



Direct-Q[®] 3, 5, 8 system
Direct-Q 3 UV, 5 UV, 8 UV system
User manual



Notice

The information in this document is subject to change without notice and should not be construed as a commitment by Millipore SAS. Millipore SAS assumes no responsibility for any errors that might appear in this document. This manual is believed to be complete and accurate at the time of publication. In no event shall Millipore SAS be liable for incidental or consequential damages in connection with or arising from the use of this manual.

We manufacture and sell water purification systems designed to produce pure or ultrapure water with specific characteristics ($\mu\text{S}/\text{cm}$, T, TOC, CFU/ml, Eu/ml) when it leaves the water purification system provided that the Direct-Q Systems are fed with water quality within specifications, and properly maintained as required by the supplier.

We do not warrant these systems for any specific applications. It is up to the end user to determine if the quality of the water produced by our systems matches his expectations, fits with norms/legal requirements and to bear responsibility resulting from the usage of the water.

Copyright

© 2012 MILLIPORE SAS. PRINTED IN FRANCE. ALL RIGHTS RESERVED. THIS BOOK OR PARTS THEREOF MAY NOT BE REPRODUCED IN ANY FORM WITHOUT THE WRITTEN PERMISSION OF THE PUBLISHERS.

THE PHOTOS ARE NON-CONTRACTUAL.

FTPF09550

V5.0 – 05/2012

Trademarks

Millipore, Direct-Q, SmartPak, Millipak, Millex, BioPak and EDS-Pak are registered trademarks of Merck KGaA. VOC-Pak is a trademark of Merck KGaA.

The "M" Mark is a trademark of Merck KGaA.

All other trademarks are trademarks of their respective manufacturers.

Product warranty and limitation of liability

The applicable warranty and limitation of liability for the products listed in this publication may be found at <http://www.millipore.com/ec/cp3/terms> within the "Terms and Conditions of Sale" applicable to your purchase transaction.



Directive 2002/96 EC: For European users only

The symbol "crossed bin" on a product or its packaging indicates that the product should not be treated like household waste when discarded. Instead the product should be disposed of at a location that handles discarded electric or electronic equipment.

Proper disposal of equipment containing electric or electronic components will help to reduce pollution effects to the environment or to human health. Proper recycling of these products helps in environmental preservation and helps to protect natural resources. For more information about recycling of products containing electric or electronic components, please contact your local recycling representative or organisation.

Table of Contents

Introduction	1
Using this Manual	1
Safety Information	1
Contacting Millipore® SAS.....	2
Product Information	3
Direct-Q System Overview	3
Direct-Q System Product Water Specifications	3
Schematic of Main Components.....	4
Operating principle	4
Technical Specifications	5
Pre Installation	7
Installation Requirements.....	7
Optional Equipment You May Need	8
Unpacking the Direct-Q System – What's Inside?	8
Installation.....	9
Preparation of the System	9
Connection of Tubing for a Direct-Q 3 (UV) System.....	9
Connection of tubing for Direct-Q 5 (UV) and Direct-Q 8 (UV) Systems.....	12
Connection of the Power Cord – Turning on the System Power	13
Installation of the SmartPak cartridge	14
Flush Mode.....	16
Calibration of the Tank Level for Direct-Q 5 (UV) and Direct-Q 8 (UV) Systems	17
Installation of the Vent Filter.....	20
Installation of the Tygon® Tubing.....	20
Purging Air from the System.....	21
Hydrating the System.....	22
Installation and Rinsing of the Final Filter	23
How to Calibrate the Flowrate from the Direct-Q System (F02).....	24
How to Show Resistivity or Conductivity Units (C01).....	26
How to Set the Resistivity Setpoint (C02).....	28
Using the Direct-Q System	31
Understanding the Display.....	31
How to Get Water from the Direct-Q System	31
How to Dispense an Exact Amount of Product Water (F01).....	32
Operating Modes.....	34

How to view the Product Resistivity and Temperature in Filling Tank mode or in Pre Operate mode..	37
How to view the RO Permeate Conductivity in Filling Tank mode or in Pre Operate mode	37
How to recirculate water manually before dispensing	37
How to Understand Direct-Q System messages.....	38
Maintenance	41
Maintenance Schedule.....	41
How to Replace the SmartPak Cartridge.....	43
Flush Mode.....	45
How to Replace the Final Filter.....	48
How to Clean the Screen Filter.....	49
How to Calibrate the Tank Level (C04).....	50
How to Empty the Tank (C03).....	52
How to Sanitize the System	53
How to Sanitize the Tank only.....	57
How to Replace the UV Lamp (UV System only)	61
How to View or Reset the UV Lamp Timer (C05)	65
Troubleshooting	67
Ordering Information	71
Catalogue Numbers for Direct-Q Systems.....	71
Catalogue Numbers for Consumables.....	71
Catalogue Numbers for Accessories	71

Using this Manual

This User Manual is a guide for use during the installation, normal operation and maintenance of a Direct-Q® 3, 5, 8 or a Direct-Q 3, 5, 8 UV Water Purification System. 'Direct-Q' is used in this manual to refer to either the Direct-Q 3, 5, 8 system or the Direct-Q 3 UV, 5 UV, 8 UV system unless otherwise noted. It is highly recommended to completely read this manual and to fully comprehend its contents before attempting normal operation or maintenance of the Water Purification System.

Safety Information

Your Direct-Q System should be operated according to the instructions in this manual. In particular, the hydraulic and electrical specifications should be followed and met. It is important to use this equipment as specified in this manual; using this equipment in a different manner may impair the safety precautions of the Direct-Q System.

Symbol

What it means



This HAZARD symbol is used to refer to instructions in this manual that need to be done safely and carefully.



This ATTENTION symbol is used to refer to instructions in this manual that need to be done carefully.



This UV RADIATION sticker is used to refer to a position on the system cabinet or inside of it where exposure to uv light is possible.



This DANGER sticker is used to refer to a position on the system cabinet or inside of it that could be hazardous.



This ELECTRICAL GROUND sticker is used to refer to a position on the system cabinet or inside where an electrical ground connection is made.



This ELECTRICAL DANGER sticker is used to refer to a position on the system cabinet or inside where an electrical danger could exist.

Introduction

Contacting Millipore® SAS

Internet

The Internet Site can be used to find addresses, telephone/fax numbers and other information.

Internet Site Address: www.millipore.com
www.millipore.com/techservice
www.millipore.com/lab_water

Manufacturing Site

Millipore SAS
67120 Molsheim
FRANCE

Direct-Q System Overview

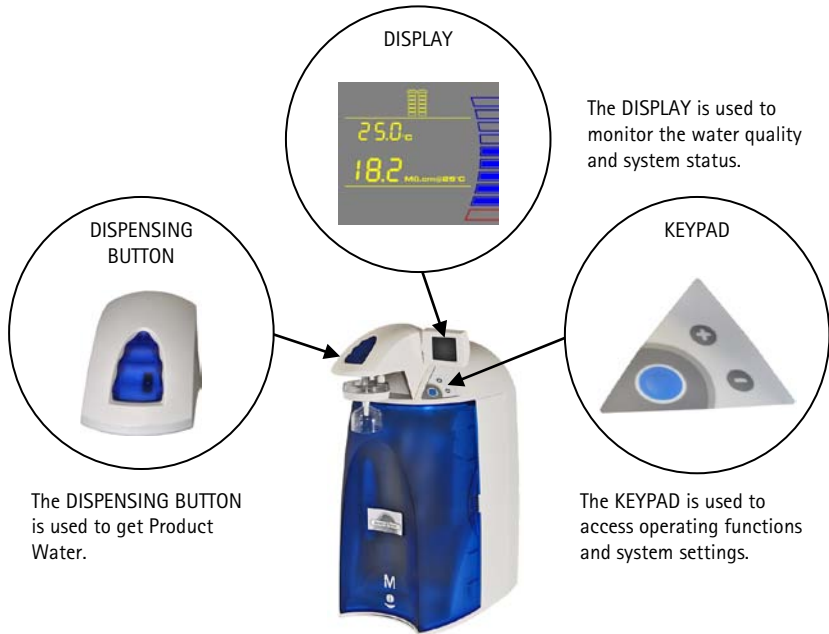

Direct-Q System Product Water Specifications

Water Flowrate Specifications

Direct-Q System Type	RO water flowrate	Dispensing flowrate	Reject water flowrate (5°C < T < 35°C)
Direct-Q 3	3 LPH ± 15% @ 25°C	Up to 42 LPH	15 LPH to 25LPH
Direct-Q 5	5 LPH ± 15% @ 25°C	Up to 42 LPH	35 LPH
Direct-Q 8	8 LPH ± 15% @ 25°C	Up to 42 LPH	35 LPH

Product Water Quality

Resistivity	18.2 MΩ.cm @ 25 °C
Conductivity	0.056 μS/cm @ 25 °C
Total Organic Carbon (TOC)	< 5 μg/L (ppb) (with UV) < 10 μg/L (ppb) (without UV)
Micro-Organisms	< 0.1 CFU/ml (with Millipak® Filter)

Product Information

Schematic of Main Components

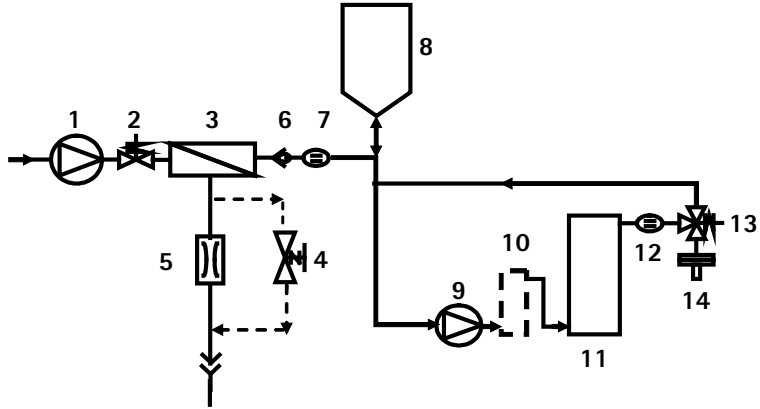

- | | |
|----------------------------------------------------------|------------------------------------------------------------|
| 1 Booster Pump | 8 Tank |
| 2 Inlet Solenoid Valve | 9 Distribution Pump |
| 3 SmartPak® cartridge
(Pretreatment and RO Cartridge) | 10 UV Lamp 185 nm (UV System) |
| 4 RO Reject Solenoid Valve | 11 SmartPak cartridge
(Ion Exchange Polisher Cartridge) |
| 5 RO Reject Capillary | 12 Product Resistivity Cell |
| 6 Check Valve | 13 Point-of-Use (POU) Solenoid Valve |
| 7 RO Permeate Conductivity Cell | 14 Final Filter |

Operating principle

Potable tap water enters the SmartPak cartridge through the Booster Pump. The SmartPak cartridge for the remainder of this manual is an all-in-one twin-cartridge containing three water purification technologies. The first cartridge combines Pretreatment media and a Reverse Osmosis (RO) membrane. The second cartridge contains Ion Exchange resin. The SmartPak cartridge is a consumable device that needs to be periodically replaced during the maintenance of the system.

Tap water is pretreated to protect the RO membrane from organic fouling and chlorine oxidation. The RO membrane has 2 exiting streams: permeate (pure water) and reject. The permeate water that went through the RO membrane is stored temporarily in the tank. The ions, particles, organic molecules and bacteria rejected by the RO membrane are sent to the drain via the Reject Tubing.

During Dispensing mode, the Distribution Pump turns on. The RO water is pumped from the tank into the UV Lamp (UV System). The UV Lamp emits light at 185 nm and 254 nm. It is used to reduce levels of organic molecules in the water. The UV Lamp is a consumable device that needs to be periodically replaced during the maintenance of the system. The RO water is then sent to the Ion Exchange Polisher cartridge to deionize the water. The Final Filter is a membrane based filter that removes all particles and bacteria with a size greater than the filter pore size. The Final Filter is a consumable device. Product Water is regularly recirculated to enhance the quality of water delivered from the Direct-Q System.

Technical Specifications

Dimensions

System Height, Width and Depth

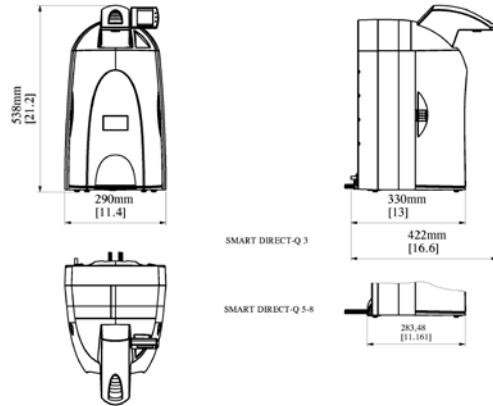

Shipping Box

- Height: 56 cm
- Width: 42 cm
- Depth: 64 cm

Weight

SYSTEM	Direct-Q 3	Direct-Q 5	Direct-Q 8	Direct-Q 3 UV	Direct-Q 5 UV	Direct-Q 8 UV
Operating Weight	17.6 kg	11.6 kg	11.6 kg	18.2 kg	12.2 kg	12.2 kg
Dry Weight	8.1 kg	7.1 kg	7.1 kg	8.6 kg	7.6 kg	7.6 kg
Shipping Weight	12.3 kg	11.3 kg	11.3 kg	12.8 kg	11.8 kg	11.8 kg

Noise Level

A Direct-Q System has a maximum noise level of 50 dB at a distance of 1 metre away.

Electrical

- 100 VAC \pm 10%, 50/60 Hz. 0.56 amp source, 2 amp T (Time Lag) fuse, Power = 80 VA
- 120 VAC \pm 10%, 50/60 Hz. 0.56 amp source, 2 amp T fuse, Power = 80 VA
- 230 VAC \pm 10%, 50/60 Hz. 0.31 amp source, 2 amp T fuse, Power = 80 VA



The source of electrical power should be within 2.5 metres of the system. The source of electrical power must be earth grounded.

Installation Requirements

Feedwater Requirements

Type of Feedwater	Potable
Flowrate	≥ 40 LPH
Minimum Pressure	≥ 0.5 bar
Maximum Pressure	≤ 6 bar
Conductivity	< 2000 μS/cm
Temperature	5 to 35 °C
pH	4 - 10
Fouling Index	< 10
Iron	< 0.1 ppm as CaCO ₃
Aluminum	< 0.05 ppm as CaCO ₃
Manganese	< 0.05 ppm as CaCO ₃
Free Chlorine	< 1 ppm
Langelier Saturation Index	< + 0.2
TOC	< 2000 ppb

Feedwater Connection Needed

Feedwater Piping Connection	1/2 inch Male GAZ, NPTM or BSPM
-----------------------------	---------------------------------

Reject Flow Requirement

Drain Capacity	30 LPH
----------------	--------

Environmental Requirements

Indoor Use Only	
Storage Temperature	5 °C < T < 40 °C
Operating Temperature	5 °C < T < 40 °C
Relative Humidity	Should not exceed 80% for temperatures below 31 °C Should stay within 50% to 80% between 31 °C and 40 °C.
Altitude	< 3000 metres
Installation Category	II
Pollution Degree	2

Pre Installation

Optional Equipment You May Need

Wall Mounting Bracket

The Millipore SAS Catalogue Number for the Wall Mounting Bracket is WMBSMT001. The mounting hardware for attaching the bracket to a wall is not included and must be supplied.

External Tank Connector

The Millipore SAS Catalogue Number for a Tank Connector Kit is TANKPECKT. An external tank holding up to 30 or 60 Litres can be used instead of the internal 6 Litre tank. The Tank Connector Kit is used to connect the 30 L tank to the system. The mounting hardware for connecting the external tank to the system is not included and must be supplied.

The Millipore SAS Catalogue Number for the 30 L PE Reservoir is TANKPE030.

The Millipore SAS Catalogue Number for the 60 L PE Reservoir is TANKPE060.

NOTE:

An external tank is required for the use of Direct-Q 5 (UV) and Direct-Q 8 (UV) Systems.

Unpacking the Direct-Q System – What's Inside?

Open the Direct-Q System Shipping Box. Use the checklist included in the Accessories Bag to make sure all items were shipped and are accounted for. It is highly suggested to become familiar with the items that are shipped since these will be used in the Installation section of this manual.

Contact Millipore SAS if an item is missing.

Preparation of the System



- Open the front cover.
(this may require to remove the final filter)
Locate the tie wrap used to hold the Booster Pump in place during shipping (A).



- Press on the tab of the tie wrap (B).
Remove and pull the tie wrap out.



- Locate the protective foam found at the UV lamp cable.
Remove it (C).

Connection of Tubing for a Direct-Q 3 (UV) System

(Go directly to *section "Connection of tubing for Direct-Q 5 (UV) and Direct-Q 8 (UV) Systems"*)



- Rotate the Direct-Q 3 (UV) System so you can see the back of the system (see photo A).

1. Feedwater tubing
2. Reject tubing
3. Overflow tubing
4. Tank outlet

Installation

Feedwater Tubing

B



- Locate the Feedwater Tubing exiting from the bottom middle of the system (B).
A 1/2 inch Female GAZ fitting with a screen filter is attached at the end of this tubing.
Unroll it until the fitting reaches the Feedwater source.

- Apply white tape on the thread of the 1/2 inch Male GAZ valve or fitting of the Feedwater source.

C



- Connect the fitting to the valve (C).

Reject Tubing

D



- Locate the Reject Tubing exiting from the bottom middle of the system (D). Unroll it.

- Secure the tubing into a sink or drain.

Overflow Tubing

E



- Locate the Overflow Tubing exiting from the bottom right of the system (E). Unroll it.

- Secure the tubing into a sink or drain.

Pure Permeate Tubing

F



-
- Locate the Tank Outlet Valve, the Pure Permeate Outlet Tubing and the adaptor fitting in the Accessories Bag.
 - Install the Tank Outlet Valve and Tubing as shown (F, G and H).
-

G



H



I



-
- Open the Tank Outlet Valve (I).
This allows the tank to be emptied of any water in it.
This is necessary when the SmartPak cartridge is flushed with water after it is installed.
-

Installation

Connection of tubing for Direct-Q 5 (UV) and Direct-Q 8 (UV) Systems

A



- Rotate the system so you can see the back of the system (A).

1. Feedwater tubing
 2. Reject tubing
 3. Tubing to tank
 4. Level Sensor from Reservoir
-

Feedwater Tubing

B

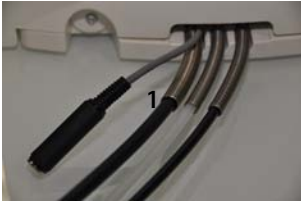

- Locate the Feedwater Tubing exiting from the bottom middle of the system (1).
A 1/2 inch Female GAZ fitting with a screen filter is attached at the end of this tubing.
Unroll it until the fitting reaches the Feedwater source.
 - Apply white tape on the thread of the 1/2 inch Male GAZ valve or fitting of the Feedwater source.
-

C



- Connect the fitting to the valve (C).
-

Tubing to tank

D



- Locate the permeate tubing shown (3).
Unroll it and place it to a drain.
-

Reject Tubing

E



- Locate the Reject Tubing exiting from the bottom middle of the system (E). Unroll it.
 - Secure the tubing into a sink or drain.
-

Connection of the Power Cord – Turning on the System Power



- Open the front cover of the system (A). (this may require to remove the final filter)
This will allow the system to go into STANDBY mode once the system is powered.
-

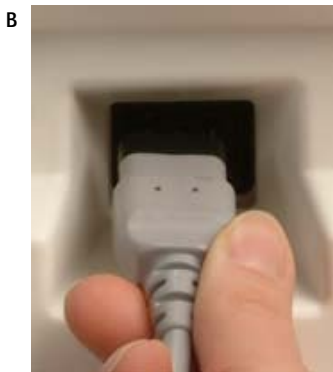

- Plug the Power Cord into the system (B).
 - Plug the other end of the Power Cord into an appropriate source of electrical power (i.e. wall outlet). The system is immediately powered.
 - Open the Feedwater Supply Valve.
-

Start-up Displays

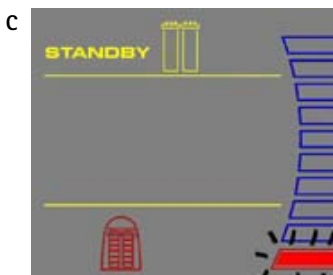

- Once the system is powered, the system will start to display information about the software before going into STANDBY mode (C).
-

Installation

Installation of the SmartPak cartridge



Open the Tank Outlet Valve before installing a new SmartPak cartridge. This keeps the tank from filling until the SmartPak cartridge is rinsed out (A).



Do not touch the UV Lamp when replacing the SmartPak cartridge.

Installation

A



- Make sure the front cover is opened.
(this may require to remove the final filter)

B

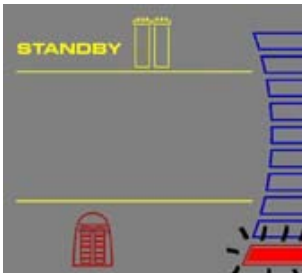

- STANDBY should be viewed on the Display (B).
- Remove the SmartPak cartridge from its shipping box.
- Remove the protective caps on the ports of the SmartPak cartridge and from the system.

C



- Locate the O-rings on the ports (C).
Wet them with water. It is preferable to wet them with ultrapure water.

D



- Install the SmartPak cartridge
-

E



- Check that the SmartPak Cartridge it is fully seated into the system ports as shown
-

F



- CLOSE THE FRONT COVER.
-

G



NOTE:

The Tank Outlet Valve should be left open (G)

Installation

Flush Mode



The Tank Outlet Valve should be left open during FLUSH mode.

H



- The system will now go into FLUSH mode for 15 minutes (H). This is done to empty the SmartPak cartridge of air and hydrate the material inside.

I

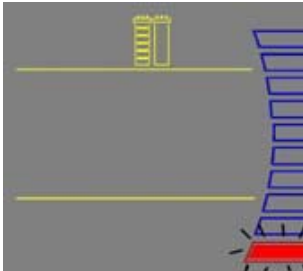

- When FLUSH mode is finished, the system will go into FILLING TANK mode automatically (I).

Calibration of the Tank Level for Direct-Q 5 (UV) and Direct-Q 8 (UV) Systems

The Analogue Level Sensor has a Signal Voltage measured by the PCB. There is a Signal Voltage corresponding to an empty Reservoir. There is a Signal Voltage corresponding to a full Reservoir.

The TANK LEVEL Calibration is done by telling the software which Signal Voltage represents a full Reservoir and which Signal voltage represents an empty Reservoir.

NOTE:

The TANK LEVEL Calibration is used to calibrate the Level Sensor Signal Voltage relative to the water level inside the Reservoir.



Connect the 6mm diameter tubing via an 8 to 6mm fitting to the bottom of the Reservoir and the level sensor of the tank to the level sensor jack input



Press the Main and "+" Buttons together to enter the menu. The Display will show C01.

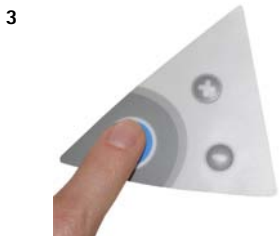

Press the Main Button 3 times. The Display will show C04. The highest Tank Level display will be blinking. This means that the highest water level is ready to be calibrated.

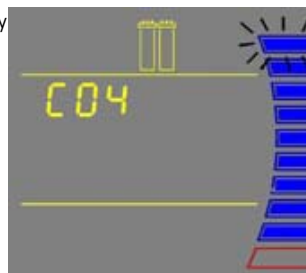

Installation

4

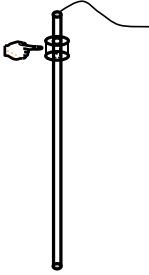

Move the Float on the Level Sensor to its highest possible position (representing a full Reservoir). Make sure the full water level is below the overflow port.

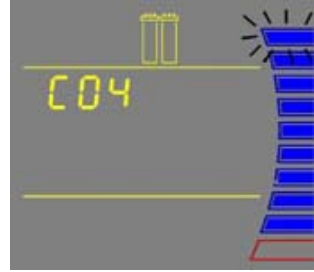

5

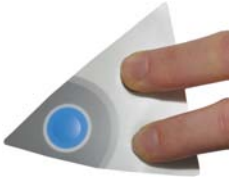

Press the "+" and "-" Buttons together to enter the highest water level. The Signal Voltage at that position becomes defined as the '100%' position. The Display will show the lowest Tank Level (red level) display blinking.

NOTE:

The highest and lowest tank level must be calibrated together or else the tank level is not calibrated.



6

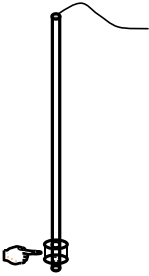

Move the Float on the Level Sensor to its **lowest** position (representing an empty Reservoir). Press LOW.

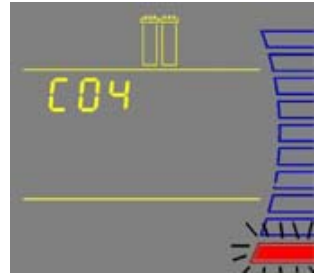

7



Press the "+" and "-" Buttons together to enter the lowest water level. The Signal Voltage at that position becomes defined as the '0%' position. The Display will exit the menu option and go into FILLING TANK mode.

The Tank Level is now calibrated.

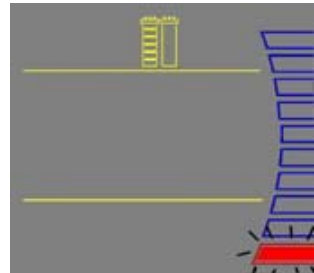

Rinsing the SmartPak cartridge



-
- Let FILLING TANK mode run for a minimum of 2 hours with the Tank Outlet Valve open and placed to the drain. This will completely rinse the purification media inside the SmartPak cartridge.

NOTE:

for sensitive applications, it is recommended to leave the system in FILLING TANK overnight to ensure complete rinsing of the RO membrane.

- Close the Tank Outlet Valve (J) and connect it back to the system if needed. The tank will start to fill up with water. It could take approximately 1.5 to 2 hours to fill the tank. When it is full, the Display will indicate a full tank by illuminating the symbols representing the Tank Level.
(see Section Understanding the Display).
 - The Vent Filter needs to be installed.
(see Section Installation of the Vent Filter).
-

Installation

Installation of the Vent Filter

This procedure is for a Direct-Q 3 (UV) System, for Direct-Q 5 (UV) system and Direct-Q 8 (UV) Systems, refer to the User Manual of your Reservoir.

A



- Obtain the Vent Filter.
- Insert the Vent Filter firmly into the port (A, B).

B



Installation of the Tygon® Tubing

C



- Locate the clear Tygon Tubing and the Barbed Fitting from the Accessories Bag.
- Screw the Barbed Fitting onto the bottom end of the POU Dispenser (C).

D



- Push one end of the Tygon Tubing onto the end of the Barbed Fitting (D). Place the other end of the Tygon Tubing in a sink.



ATTENTION

Do not use any white tape on the threads of the Barbed Fitting. An O-ring is located inside the POU Dispenser to ensure water tightness between the threads of the POU Dispenser and the Barbed Fitting.

Purging Air from the System

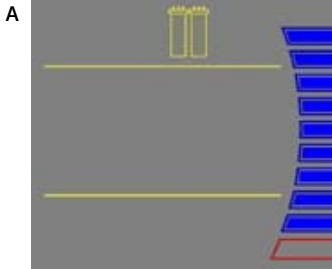

- At this time you should have installed the SmartPak cartridge, Barbed Fitting and the Tygon Tubing. Air trapped in the SmartPak cartridge should now be purged from the system.
- Verify that you have a full tank of RO water by viewing the Tank Level display (A).



- Press the Dispensing Button once to put the system into DISPENSING mode (B).

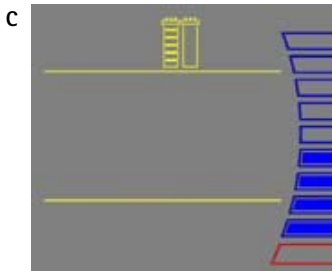

- Dispense the full tank of water from the system.
- The system will go into FILLING TANK mode when the tank level is below the 60% level (C).
- When the tank level reaches the minimum level, the system will finish dispensing water.

Installation

Hydrating the System

- At this time, the Final Filter is not installed. Leave the system overnight or for several hours in FILLING TANK mode or PRE OPERATE mode (see *Section Operating Modes*). The system will regularly recirculate water and rinse off purification media inside the SmartPak cartridge. Do not leave the system in STANDBY mode.
 - (The next morning) Press the Dispensing Button once to put the system into DISPENSING mode.
 - Allow about 1 Litre of water to be dispensed from the system.
 - Press the Dispensing Button once again. The system will finish dispensing water.
 - Remove the Tygon Tubing and the Barbed Fitting from the POU Dispenser.
 - The Final Filter needs to be installed. See *Section Installation and Rinsing of the Final Filter*.
-

Installation and Rinsing of the Final Filter



- Obtain a Final Filter.
- Remove the Tygon Tubing and the Barbed Fitting from the POU Dispenser.
- Screw the Final Filter onto the end of the POU Dispenser. The Final Filter should be turned until it is hand tight (A). Do not over tighten the Final Filter.



ATTENTION

Do not use white tape on the threads of the Final Filter. The POU Dispenser has an O-ring inside which provides a watertight seal.



- Press the Dispensing Button once. This will bring the system into DISPENSING mode.
- Locate the air vent valve (not present on all types of Final Filters) on the top side of the Final Filter. Open this slowly but do not remove it.(B). Allow any air on the clear side of the Final Filter to be vented out.



ATTENTION

Air will not pass through the membrane filter in the Final Filter. If there is trapped air, then a reduction in Product Water flowrate can result.



- Dispense about 1 Litre of water. Make sure all air is purged out.
- Press the Dispensing Button once again. The system will finish dispensing water.
- Leave the system in FILLING TANK mode.



ATTENTION

It is highly recommended not to put Tygon Tubing or any other type of tubing on the end of the Final Filter. This can compromise the Product Water quality (bacteria can grow in the Tygon Tubing).

The Water System is now ready for use.

Installation

How to Calibrate the Flowrate from the Direct-Q System (F02)

Before calibrating the Product flowrate from the Direct-Q System, you will need a 1 Litre graduated cylinder to measure the total volume of water that will be dispensed. The Final Filter should be installed.

- 1 Press the Main and "-" Buttons together to enter the menu. The Display will show F01.

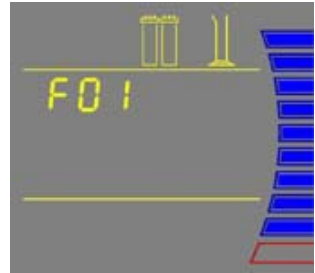

- 2 Press the Main Button once. The Display will show F02 and the 60 second timer. The graduated cylinder will be blinking.



- 3 Press the Dispensing Button once. The system will dispense water for 60 seconds. The Display will show the timer counting down.



NOTE:

If you press the Dispensing Button again or if the Tank Level display is at the 10% level before 60 seconds have elapsed, then the system will stop dispensing water. Calibration of the flowrate is cancelled.

Continued on next page

4



How to Calibrate the Flowrate from the Direct-Q System (F02) Measure the total volume of water (in Litres) dispensed from the system using a 1 L graduated cylinder.

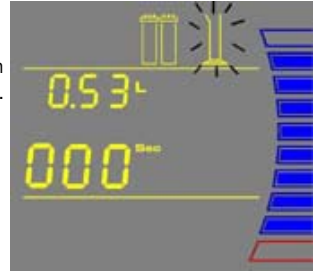

5



Press the "+" or "-" Button to match the volume Display to the volume measured.

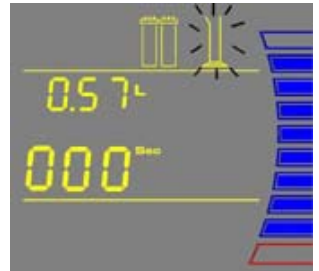

6



To exit the menu, press and hold the Main Button for 2 seconds.

To display the next menu option, press the Main Button once.

The Product Water flowrate is now calibrated.

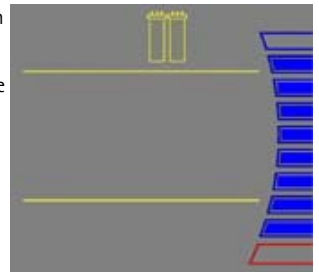

Installation

How to Show Resistivity or Conductivity Units (C01)

With Temperature Compensated or non Temperature Compensated values

Temperature compensation is a way of 'standardizing' Resistivity or Conductivity to measurements that would be seen if the water temperature was 25 °C.

1 Press the Main and "+" Buttons together to enter the menu. The Display will show C01 and the units chosen. The following Display shows Temperature Compensated Resistivity Units: $M\Omega.cm @25^{\circ}C$.



2 Press the "+" or "-" Button to select Non Temperature Compensated Resistivity Units: $M\Omega.cm$.



3 Press the "+" or "-" Button to select Temperature Compensated Conductivity Units: $\mu S/cm @25^{\circ}C$.

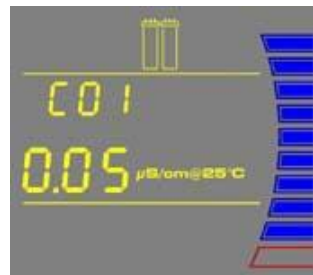

4



Press the "+" or "-" Button to select Non Temperature Compensated Conductivity Units: $\mu\text{S}/\text{cm}$.

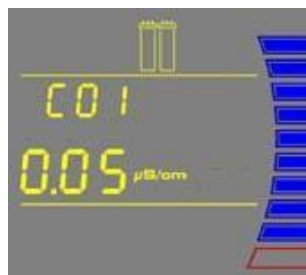

5



To exit the menu, press and hold the Main Button for 2 seconds.

To display the next menu option, press the Main Button once.

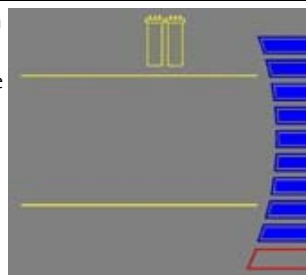

Installation

How to Set the Resistivity Setpoint (C02)

The Resistivity Setpoint is used to inform you when the Product resistivity is low. When the resistivity is below the setpoint, the Resistivity display will flash and the red Pack Alarm will be blinking (see *Section How to Understand Direct-Q System messages*). The factory default resistivity value is set to 15 MΩ.cm @25 °C.



Press the Main and "+" Buttons together to enter the menu. The Display will show C01.

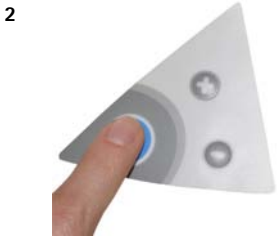

Press the Main Button once. The Display will show C02 and the Resistivity Setpoint value.

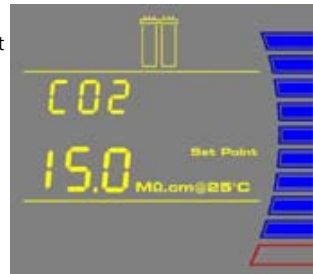

Press the "+" or "-" Button to adjust the Resistivity Setpoint from 1.0 MΩ.cm @25 °C to 18.0 MΩ.cm @25 °C.

If Conductivity Units are chosen in C01, then the Setpoint can be adjusted from 0.999 μS/cm @25 °C to 0.055 μS/cm @25 °C.

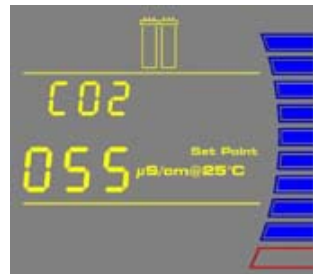

NOTE:

The Conductivity Setpoint display needs to be multiplied by 0.001 to get the real value. For example, if the Display reads "055" μS/cm @25 °C, then you would multiply 055 x 0.001 = 0.055. Thus, the real Conductivity Setpoint reading is 0.055 μS/cm @25 °C.

4



To exit the menu, press and hold the Main Button for 2 seconds.

To display the next menu option, press the Main Button once.

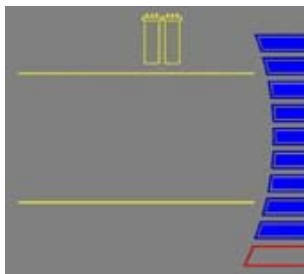

Understanding the Display

The Display is used to view information about the Operating Modes, the Operating Parameters, Maintenance or Alarm messages and the Tank Level.

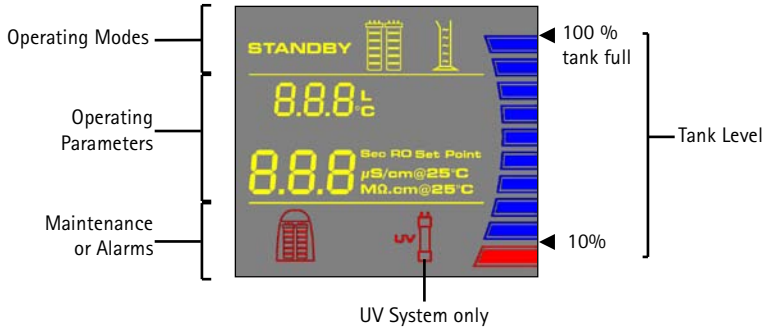

How to Get Water from the Direct-Q System

Product Water Using the Dispensing Button

There are two ways to get water using the Dispensing Button:

Press once and release.



To stop dispensing water, press the Dispensing Button once again.

OR

Press and hold down.



To stop dispensing water, release the Dispensing Button.

The system will dispense water continuously until the 10% Tank Level display is reached. At the 10% level, the system will automatically stop dispensing water.

Using the Direct-Q System

RO Water Using the Tank Outlet Valve

A



TANK OUTLET VALVE

- On a Direct-Q 3 (UV) System:
RO Water is obtained from the Tank Outlet. Open the Tank Outlet Valve when RO Water is needed (A).
-
- On Direct-Q 5 (UV) and Direct-Q 8 (UV) Systems:
RO Water is obtained from the valve located on the front of your reservoir.
-

How to Dispense an Exact Amount of Product Water (F01)

1



Press the Main and "-" Buttons together to enter the menu. The Display will show F01.

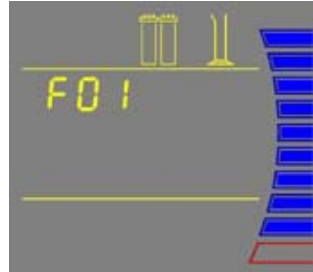

2



Press the "+" or "-" Button to adjust the exact amount of Product Water (in Litres) needed. Pre-set volumes of water can be adjusted from 0.25 L to 9.75 L in 0.25 increments.

NOTE:

The accuracy of this is dependent upon the accuracy of the Flow Calibration performed in Section How to Calibrate the Flowrate from the Direct-Q System (F02).

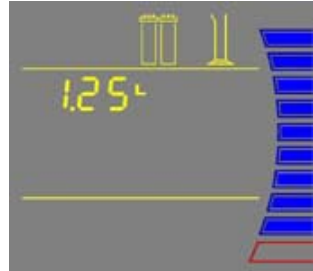

3



Press the Dispensing Button once. The system will dispense water. The Display will show the amount of water dispensed and the Product resistivity.

NOTE:
To stop dispensing water, press the Dispensing Button once again.



4



To exit the menu, press and hold the Main Button for 2 seconds.

To display the next menu option, press the Main Button once.

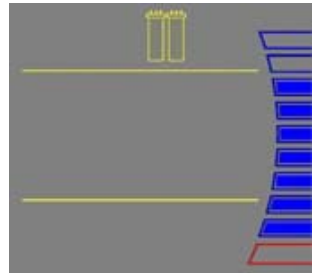

ATTENTION

The Direct-Q water systems has been designed to operate permanently connected to feed water, plugged to an electric power source and in regular operating mode. Do not unplug the Direct-Q system except when required by the user manual for maintenance purposes. Do not place the system in STANDBY mode except when maintenance needs to be performed.

Using the Direct-Q System

Operating Modes

Standby

STANDBY mode is displayed when the front cover is removed. The system will depressurize during which STANDBY will be blinking on the Display for 10 seconds. All system operations are disabled. STANDBY mode is selected before attempting maintenance on the system.

A digital display showing the word "STANDBY" in yellow capital letters on a dark grey background.

Flush

FLU (FLUSH) mode is displayed for 15 minutes after a new SmartPak cartridge has been installed and the front cover has been closed. FLUSH mode allows tap water to enter and rinse the new SmartPak cartridge. The Tank Outlet Valve must be opened during the FLUSH cycle to keep the tank from filling until the SmartPak cartridge is rinsed.

A digital display showing "FLU" on the top line and "15" on the bottom line, both in yellow on a dark grey background.

FLUSH mode is stopped if the front cover is removed to go into STANDBY mode. When the front cover is closed, FLUSH mode resumes from the last remaining time on the Display.

If the system is powered OFF during FLUSH mode and powered back ON, then a new FLUSH cycle will start.

The system will have a 2 minute FAST FLUSH cycle every 24 hours of PRE OPERATE mode.



Filling Tank

FILLING TANK mode is displayed when the tank is being filled with RO water until the 100% Tank Level display. FILLING TANK mode is launched automatically when the Tank Level display is below the 60% level or after a FLUSH cycle has been completed.



FILLING TANK mode

Water can be dispensed or can be periodically recirculated during FILLING TANK mode if the Tank Level display is above the 10% level.



Dispensing or Recirculation during FILLING TANK mode

Pre Operate

PRE OPERATE mode is displayed when the system is not dispensing water and not in FILLING TANK mode. The Tank Level display is between the 60% level and TANK FULL level.

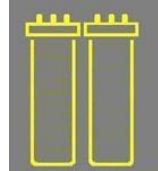

The system will have a 3-minute auto-recirculation every 2 hours in PRE OPERATE mode. The Distribution Pump turns on. This will enhance the quality of the Product Water delivered from the system. Recirculation can also be activated manually for up to 3 minutes.



The resistivity and temperature of the Product Water is displayed during recirculation. The resistivity and temperature remain displayed for up to 10 seconds after recirculation is finished.

Using the Direct-Q System

Dispensing

DISPENSING mode is displayed when Product Water is being dispensed. DISPENSING mode occurs because the Dispensing Button was pressed down. The Distribution Pump turns on.



The resistivity and temperature of the Product Water is displayed during dispensing. The resistivity and temperature remain displayed for up to 10 seconds after dispensing is stopped.



Auto-Dispensing

AUTO-DISPENSING mode is displayed when selecting menu option F01. AUTO-DISPENSING mode is used to dispense pre-set volumes of water from the Direct-Q System. The Distribution Pump turns on.

The amount of water dispensed and the resistivity are shown while water is being dispensed. The resistivity remains displayed for up to 10 seconds after dispensing is stopped.

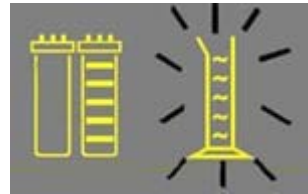

How to view the Product Resistivity and Temperature in Filling Tank mode or in Pre Operate mode

Press:



The Display will show the last Product resistivity and temperature values measured during DISPENSING mode or during RECIRCULATION. The values are displayed for 5 seconds.

NOTE:

The Product resistivity and temperature are displayed automatically during DISPENSING mode or during RECIRCULATION.

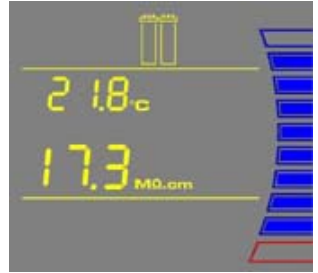

How to view the RO Permeate Conductivity in Filling Tank mode or in Pre Operate mode

Press:

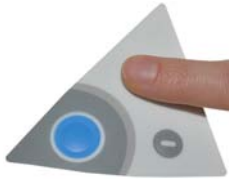

The Display will show the RO Permeate Water conductivity value that was measured during Filling Tank mode. The displayed value is not a real-time value. It is the last permeate conductivity value memorized after the system was in Dispensing Mode. The value is displayed for 5 seconds.

NOTE:

The units are displayed in $\mu S/cm$ only.

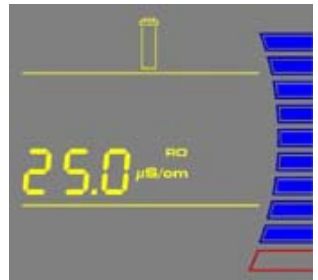

How to recirculate water manually before dispensing

This option is used to enhance the quality of the Product Water before dispensing water. The Distribution Pump will turn on and water will recirculate for up to 3 minutes. An auto-recirculation occurs for 3 minutes every 2 hours.

Press:



The Display will show the Product resistivity and temperature.

NOTE:

To dispense water, press the Dispensing Button during recirculation. Recirculation will stop and water will be dispensed.

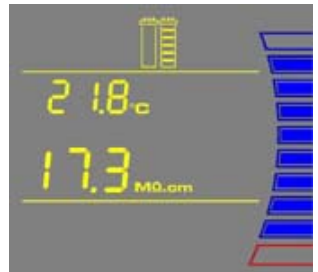

Using the Direct-Q System

How to Understand Direct-Q System messages

Pack Alarm

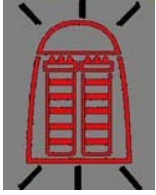

- The system will prompt you to change the SmartPak cartridge using a red Pack Alarm icon. The Display will show the red Pack Alarm blinking. The SmartPak cartridge is changed due to either the amount of time it has been used or from the amount of water that has passed through it.



- When the Resistivity display is blinking, the red Pack Alarm will also be blinking. This indicates that the SmartPak cartridge should be replaced. This message is shown when the Product resistivity is less than the Resistivity Setpoint. The Resistivity Setpoint can be seen in menu option C02.



- When the red Pack Alarm is displayed as a steady icon, the SmartPak cartridge is not installed correctly or not installed at all. If the SmartPak cartridge has been reinstalled and the Alarm is still displayed, then contact your technical support.

UV Lamp Alarm

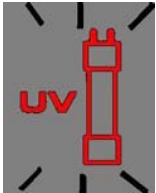

- The system will prompt you to change the UV Lamp using a red UV Lamp Alarm icon. The Display will show the red UV Lamp Alarm blinking. The message is shown when the UV Timer displays 0 days. The UV Timer can be viewed in menu option C05. The replacement of the UV Lamp involves the installation of a new UV Lamp and a manual reset of the UV Timer.



- When the red UV Lamp Alarm is displayed as a steady icon, the UV Lamp is not installed correctly or not installed at all. If the UV Lamp has been reinstalled and the Alarm is still displayed, then contact your technical support.



Flush: Open Tank Outlet Valve



- Before FLUSH mode starts, the tank has to be emptied of water. The FLU counter display will be blinking if the system has detected that there is water in the tank. The Tank Outlet Valve must be opened. The system will automatically resume FLUSH mode when the tank is emptied of water.
-

Maintenance Schedule

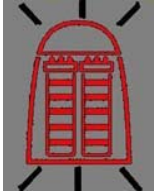
In order to maintain good performance of your water system respect the maintenance schedule and replace consumables as required.

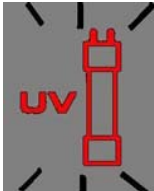
What to do	When?	How to?
<p>SmartPak cartridge Replacement</p>	<p>When the Pack Alarm display is blinking.</p>  <p>When the system resistivity display is blinking.</p>  <p>After a system or tank sanitization.</p>	<p>See Section How to Replace the SmartPak Cartridge</p>
<p>Final Filter Replacement</p>	<p>The Final Filter is replaced when the SmartPak cartridge is replaced or when the Product Water flowrate drops.</p>	<p>See Section How to Replace the Final Filter</p>
<p>Vent Filter Replacement</p>	<p>Replaced when the SmartPak cartridge is replaced.</p>	<p>See Section Installation of the Vent Filter</p>
<p>Flow Calibration</p>	<p>When the Final Filter is replaced, or periodically.</p>	<p>See Section Installation and Rinsing of the Final Filter</p>
<p>Tank Level Calibration</p>	<p>Periodically.</p>	<p>See Section How to Calibrate the Tank Level (C04)</p>
<p>UV Lamp Replacement and UV Timer Reset</p>	<p>When the UV Lamp Alarm display is blinking.</p> 	<p>See Sections How to Replace the UV Lamp (UV System only) and How to View or Reset the UV Lamp Timer (C05).</p>

Maintenance

What to do	When?	How to?
Screen Filter Cleaning	2 times a year or as necessary.	See Section How to Clean the Screen Filter
Sanitization of the System	Once a year. The SmartPak cartridge will have to be replaced after the sanitization of the system.	See Section How to Empty the Tank (C03) and How to Sanitize the System
Sanitization of the Tank	Once a year.	See Section How to Sanitize the Tank only

How to Replace the SmartPak Cartridge



ATTENTION

Open the Tank Outlet Valve before installing a new SmartPak cartridge. This keeps the tank from filling until the SmartPak cartridge is rinsed out (A).



HAZARD

Do not touch the UV Lamp when replacing the SmartPak cartridge.

Removing the SmartPak cartridge

A



Open the front cover (this may require to remove the final filter) to go into STANDBY mode. Wait for the system to depressurize. The Display will show STANDBY blinking for 10 seconds.

- Remove the Final Filter.

B



- Press your thumbs on the system and Swing the pack towards you (B).

C



- Remove the pack from the system (C).
-

Maintenance

Installation

D



- Remove the new SmartPak cartridge from its shipping box.
- Remove the protective caps on the ports of the SmartPak cartridge.
- Locate the O-rings on the ports. Wet them with water. It is preferable to wet them with ultrapure water.
- Install the SmartPak cartridge until it is fully seated into the system ports as shown (D, E and F).

E



F



- CLOSE THE FRONT COVER.

G



NOTE:
The Tank Outlet Valve should be left open (G).

Flush Mode



The Tank Outlet Valve should be left open during FLUSH mode.



- The system will now go into FLUSH mode for 15 minutes (H). This is done to empty the SmartPak cartridge of air and hydrate the material inside.

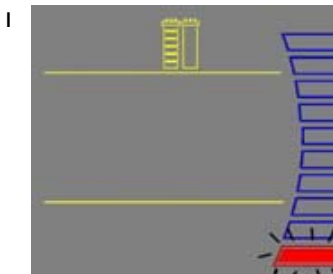

- When FLUSH mode is finished, the system will go into FILLING TANK mode automatically (I).

Rinsing the SmartPak cartridge



- Let FILLING TANK mode run for a minimum of 2 hours with the Tank Outlet Valve open and placed to the drain. This will completely rinse the purification media inside the SmartPak cartridge.

NOTE:

for sensitive applications, it is recommended to leave the system in FILLING TANK overnight to ensure complete rinsing of the RO membrane.

- Close the Tank Outlet Valve (J) and connect it back to the system if needed. The tank will start to fill up with water. It could take approximately 1.5 to 2 hours to fill the tank. When it is full, the Display will indicate a full tank by illuminating the symbols representing the Tank Level (*see Section Understanding the Display*).
- The Vent Filter needs to be installed. See *Section Installation of the Vent Filter*.

Maintenance

Replacing the Vent Filter

K



-
- This procedure is for Direct-Q 3 (UV) System, for Direct-Q 5 (UV) and Direct-Q 8 (UV) Systems, refer to the User Manual of your Reservoir.
 - The Vent Filter should be replaced whenever the SmartPak cartridge is replaced.
 - Remove the Vent Filter (K).
 - Insert the new Vent Filter into the fitting.
See Section Installation of the Vent Filter.
-

Installing the Tygon Tubing

L



-
- Install the Barbed Fitting and Tygon Tubing (L).
See Section Installation of the Tygon® Tubing.
-

Purging Air from the System

-
- *See Section Purging Air from the System.*
-

Hydrating the System

M



- Hydrate the system (M).
See *Section Hydrating the System*.
-

Replacing the Final Filter

N



- See *Section How to Replace the Final Filter* (N).

The System is now ready for use.

Maintenance

How to Replace the Final Filter

The Final Filter is normally replaced when the SmartPak cartridge is replaced or at an earlier time if it becomes clogged. A clogged Final Filter can reduce the Product Water flowrate.



ATTENTION

Make sure the SmartPak cartridge has been hydrated overnight.

A

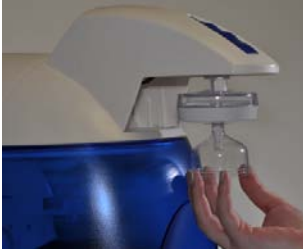

- Remove the used Final Filter.
 - Screw the new Final Filter onto the end of the POU Dispenser. The Final Filter should be turned until it is hand tight (A). Do not over tighten the Final Filter.
-



ATTENTION

Do not use white tape on the threads of the Final Filter. The POU Dispenser has an O-ring inside which provides a watertight seal.

B



- Locate the air vent valve (not present on all types of Final Filters) on the top side of the Final Filter. Open this slowly but do not remove it.(B). Allow any air on the clear side of the Final Filter to be vented out.
-



ATTENTION

Air will not pass through the membrane filter in the Final Filter. If there is trapped air, then a reduction in Product Water flowrate can result.



- Dispense about 1 Litre of water. Make sure all air is purged out.
- Press the Dispensing Button once again. The system will finish dispensing water.
- Leave the system in FILLING TANK mode.

The Water System is now ready for use.

At this time, it is highly recommended to recalibrate the Product Water flowrate. See Section *How to Calibrate the Flowrate from the Direct-Q System (F02)*.

How to Clean the Screen Filter

The purpose of the Screen Filter is to prevent large particles or other debris from entering the system. If the Screen Filter becomes blocked with debris, then the Feedwater will not flow freely to the system.

It is recommended to clean the Screen Filter twice a year or whenever it may have become clogged.

A



- Close the Feedwater Supply Valve.

Open the front cover (this may require to remove the final filter) to let the system go into STANDBY mode.

- Locate the Screen Filter. This will be located where the Feedwater 8 mm OD Tubing originates.
- Unscrew the collar that holds the Feedwater Tubing to the barbed end of the fittings (A). Pull the tubing off of the fitting.
- Unscrew the Screen Filter from the Feedwater pipe.

B



- Go to a sink and flush tap water backwards through the Screen Filter. The water should flow through the barbed end first. Any trapped debris on the Screen Filter will be flushed out (B).
- Apply 3-4 turns of new white tape to the threads of the Feedwater Pipe in a clockwise direction.
- Screw the Screen Filter back onto the Feedwater Supply Pipe.

C



- Attach the Feedwater Tubing back onto the Barbed Fitting (C).
- Open the Feedwater Supply Valve.
- Close the front cover.
- Leave the system in PRE OPERATE mode.

Maintenance

How to Calibrate the Tank Level (C04)

Before calibrating the tank level, the tank needs to be filled to the 100% level or TANK FULL.

1



Press the Main and "+" Buttons together to enter the menu. The Display will show C01.



2



Press the Main Button 3 times. The Display will show C04. The highest Tank Level display will be blinking. This means that the highest water level is ready to be calibrated.

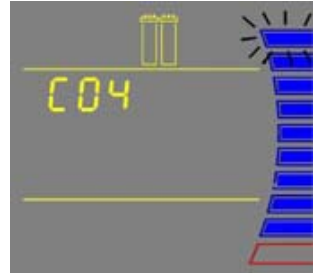

3



Press the "+" and "-" Buttons together to enter the lowest water level. The Display will show the lowest Tank Level (red level) display blinking.

NOTE:

The highest and lowest tank level must be calibrated together or else the tank level is not calibrated.

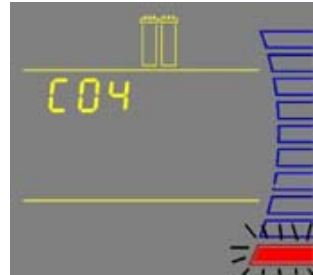

Continued on next page

4



Open the Tank Outlet Valve. Allow the tank to be emptied to its lowest water level.

NOTE: *The lowest water level is not calibrated if the amount of water emptied from the tank is less than 10%.*

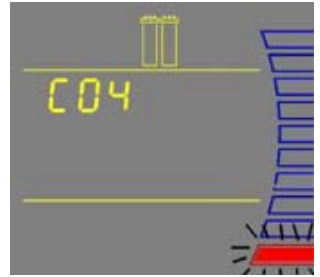

5



Close the Tank Outlet Valve.

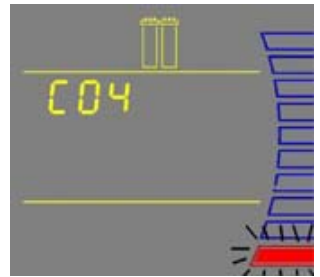

6



Press the "+" and "-" Buttons together to enter the lowest water level. The Display will exit the menu option and go into FILLING TANK mode.

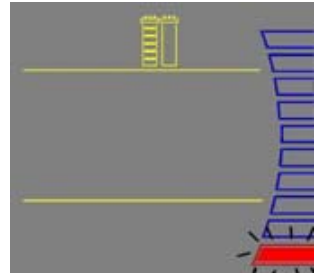

The Tank Level is now calibrated.

NOTE:

If the Display remains in the menu option and the highest tank level is blinking, then the tank level was not calibrated. The amount of water emptied from the tank was not enough (less than 10%). The tank needs to be emptied to its lowest water level. Allow the tank to fill to the 100% level and perform the calibration again.

Maintenance

How to Empty the Tank (C03)

The tank can be fully emptied of water through the POU Dispenser. This option is used when performing a system sanitization. Before emptying the tank, it is recommended to remove the Final Filter and to install the Barbed Fitting and Tygon Tubing. Place the other end of the Tygon Tubing in a sink.

1



Press the Main and "+" Buttons together to enter the menu. The Display will show C01.



2



Press the Main Button 2 times. The Display will show C03.

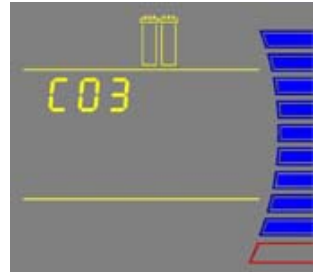

3



Press the "+" and "-" Buttons together. The system will dispense all the water in the tank through the POU Dispenser. The Tank Level display will be blinking.

NOTE:
To stop emptying the tank, press the Dispensing Button.

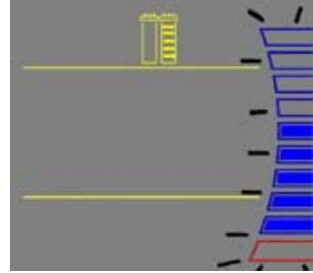

4



When the system has finished emptying the tank, the system will start FILLING TANK mode automatically.

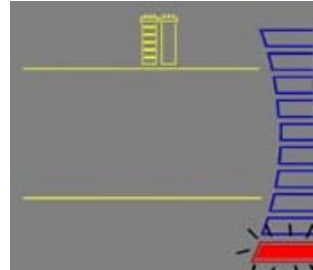

How to Sanitize the System

A system sanitization is performed to eliminate bacteria growth in both the system and in the tank. It is recommended to sanitize the system at least once a year.

This procedure is for a Direct-Q 3 (UV) System, for Direct-Q 5 (UV) and Direct-Q 8 (UV) Systems refer to the User Manual of your Reservoir.

Things to Know BEFORE you sanitize the System and the Tank



All safety precautions must be followed when handling Hydrogen Peroxide. Rubber gloves, safety goggles and a lab coat must be worn to avoid any skin and body contact.

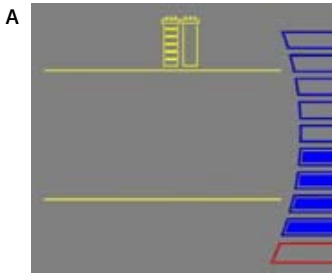

- During a system sanitization, the tank will also be sanitized.
- You will need a minimum Tank Level display of at least 50% (A).



- Locate the clear elbow fitting, the clear tubing and the syringe in the Sanitization Kit (B).
- You will need 200 ml of 30% Hydrogen Peroxide solution and 200 ml of purified water. Millipore SAS does not sell Hydrogen Peroxide but it is readily available through most Scientific Supply Companies.
- It is recommended to sanitize the system near the time the SmartPak cartridge would normally be replaced. The SmartPak cartridge, the Final Filter and the Vent Filter will need to be replaced after the sanitization is completed.
- The system will not be able to deliver Product Water while the system is being sanitized.



The total time needed to sanitize the system is at least 4.5 hours.

Maintenance

Sanitizing the System and the Tank

C



Open the front cover (this may require to remove the final filter) to let the system go into STANDBY mode (C).

D



- Remove the Vent Filter and install the clear elbow fitting from the Sanitization Kit (D).

E



- Introduce the male connector of the clear tubing firmly into the elbow fitting (E).

F



- Inject 200 ml (1 ml = 1 cc) of Hydrogen Peroxide solution (30%) into the 6 Litre tank via the clear tubing (F).
- Rinse the air vent port with 200 ml of purified water.

Continued on next page

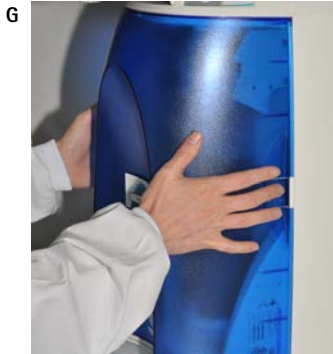

- Close the front cover (G).
The system will now go into FILLING TANK mode.
-

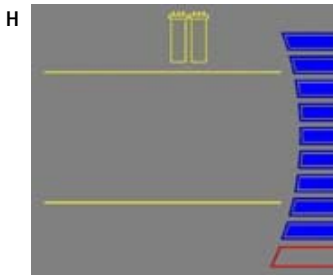

- Let the tank fill up to the 100% level (H).
-



- Let the system stand for 1 hour for effective bacteria elimination.
 - (After 1 hour) Remove the Final Filter. Install the Barbed Fitting and Tygon Tubing (I).
-

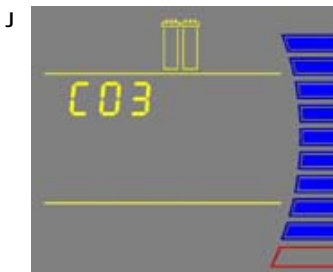

- Perform an EMPTY TANK (C03) to dispense all the water in the tank (J).
-

Continued on next page

Maintenance

K

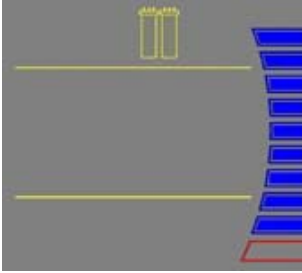

-
- Once the tank is empty, the system will now go into FILLING TANK mode. Let the tank fill up to the 100% level (K).

L

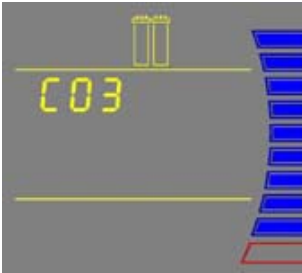

-
- Perform an EMPTY TANK (C03) again to dispense all the water in the tank (L).

M



-
- Open the front cover (this may require to remove the final filter) to let the system go into STANDBY mode (M).

The SmartPak cartridge, the Vent Filter and the Final Filter will now have to be replaced. Refer to the earlier Maintenance sections for replacement instructions.

How to Sanitize the Tank only

A tank sanitization is performed to eliminate bacteria growth in the tank only. It is recommended to sanitize the tank at least once a year.

Things to Know BEFORE you sanitize the Tank



HAZARD

All safety precautions must be followed when handling Hydrogen Peroxide. Rubber gloves, safety goggles and a lab coat must be worn to avoid any skin and body contact.

A

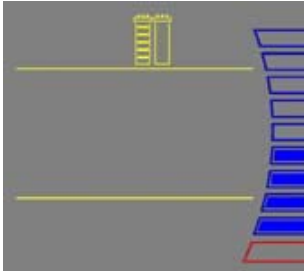

- If you have performed a system sanitization, then you do not need to perform a tank sanitization.
- You will need a minimum Tank Level display of at least 50% (A).

B



- Locate the clear elbow fitting, the clear tubing and the syringe in the Sanitization Kit (B).
- You will need 200 ml of 30% Hydrogen Peroxide solution and 200 ml of purified water. Millipore SAS does not sell Hydrogen Peroxide but it is readily available through most Scientific Supply Companies.
- The Vent Filter will need to be replaced after the sanitization is completed.
- The system will not be able to deliver Product Water while the system is being sanitized.



ATTENTION

The total time needed to sanitize the tank is at least 4.5 hours.

Maintenance

Sanitizing the Tank

C



Open the front cover (this may require to remove the final filter) to go into STANDBY mode (C).

D



- Remove the Vent Filter and install the clear elbow fitting from the Sanitization Kit (D).

E



- Introduce the male connector of the clear tubing firmly into the elbow fitting (E).

F



- Inject 200 ml (1 ml = 1 cc) of Hydrogen Peroxide solution (30%) into the 6 Litre tank via the clear tubing (F).
- Rinse the air vent port with 200 ml of purified water.

Continued on next page



- Close the front cover (G).
The system will now go into FILLING TANK mode.
-

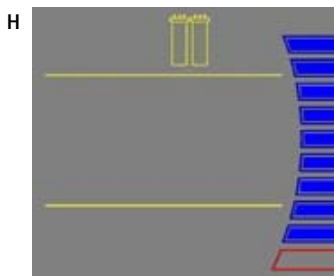

- Let the Tank Level display go up to the 100% level (H).
-

Continued on next page

Maintenance



When the tank is full, open the front cover (this may require to remove the final filter) to go into STANDBY mode (I).

- Let the system stand for 1 hour for effective bacteria elimination.

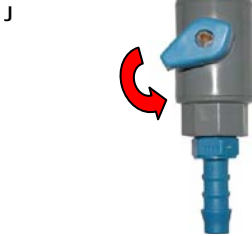

-
- (After 1 hour) Check that the Tank Outlet Tubing is secured into the drain. Open the Tank Outlet Valve to drain all the water from the tank (J).



-
- Close the Tank Outlet Valve (K).

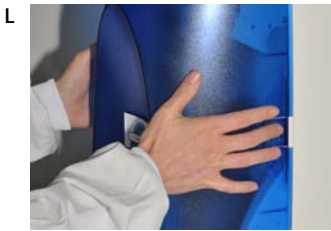

-
- Close the front cover (L).
(this may require to remove the final filter)

The system will now go into FILLING TANK mode.
Let the tank level fill up to the 100% level.

-
- Repeat steps I, J, K and L:
 - Open the front cover (this may require to remove the final filter) to go into STANDBY mode (I).
 - Check that the Tank Outlet Tubing is secured into the drain. Open the Tank Outlet Valve to drain all the water from the tank (J).
 - Close the Tank Outlet Valve (K).
 - Close the front cover (L). The system will now go into FILLING TANK mode.

The tank is now sanitized.

How to Replace the UV Lamp (UV System only)

The red UV Lamp Alarm will be blinking on the Display when it is time to exchange the UV Lamp. The message is shown when the UV Timer has reached 0 days (see *Section How to View or Reset the UV Lamp Timer (C05)*).



No electrical power should be going to the system at this time. Accidental exposure to ultraviolet light can cause damage to the eyes and skin.



Open the front cover (this may require to remove the final filter) to go into STANDBY mode (A).



- Unplug the electrical cord to power OFF the system (B).



- Remove the Final Filter.
 - Remove the SmartPak cartridge (C).
-

Maintenance

Removing the UV Lamp



The UV Lamp contains metallic Mercury. Please dispose of the used UV Lamp in a manner that is environmentally safe.

D



- Detach the Velcro® belt of the UV housing.
- Pull the UV housing out so that the UV Lamp cable is accessible (D).

NOTE:

Use the gloves supplied with the UV replacement kit.

E



- Unplug the electrical cable from the UV Lamp (E).

F



- Pull the UV Lamp out of the UV housing.(F).

Installing the new UV Lamp

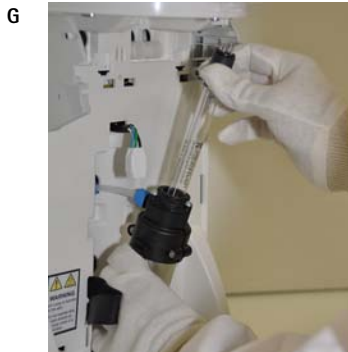

- Ensure that you use the gloves supplied with the UV replacement kit. Carefully insert the UV Lamp into the UV housing (G).



- Plug the electrical cable to the new UV Lamp (H).



- Attach the UV housing with the Velcro belt (I).



- Install the SmartPak cartridge (J).

Continued on next page

Maintenance



- Install the Final Filter.
-



ATTENTION

If the SmartPak cartridge is not being replaced, then reinstall the old SmartPak cartridge **BEFORE** powering **ON** the system. Otherwise, the system will go into **FLUSH** mode for 15 minutes during which no Product Water will be available.



- Close the front cover.
 - Plug the electrical cord to power **ON** the system.
 - Reset the UV Timer.
See Section How to View or Reset the UV Lamp Timer (C05).
-

How to View or Reset the UV Lamp Timer (C05)

The UV Lamp Timer should be reset only after the UV Lamp has been replaced (see *Section How to Replace the UV Lamp (UV System only)*). The UV Lamp Timer displays the time left until the UV Lamp needs to be replaced. The Display will show the red UV Lamp Alarm icon blinking when the Timer reaches 0 days. This message is displayed until the UV Lamp is replaced and the UV Lamp Timer is reset.

How to View the Remaining Days on the UV Lamp Timer

1



Press the Main and "+" Buttons together to enter the menu. The Display will show C01.



2



Press the Main Button 4 times. The Display will show C05 and the days left on the UV Timer.

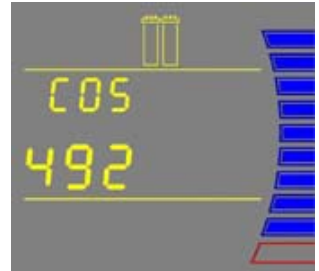

3



To exit menu, press and hold the Main Button for 2 seconds.

To display the next menu option, press the Main Button once.

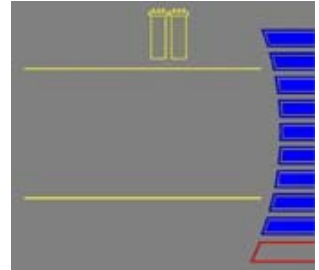

Maintenance

How to Reset the UV Lamp Timer

1



Press the Main and "+" Buttons together to enter the menu. The Display will show C01.

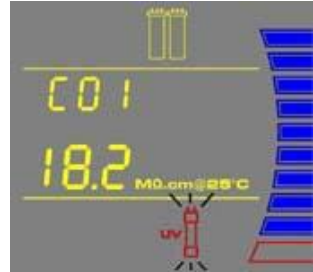

2



Press the Main Button 4 times. The Display will show C05 and "0" days left on the UV Timer.

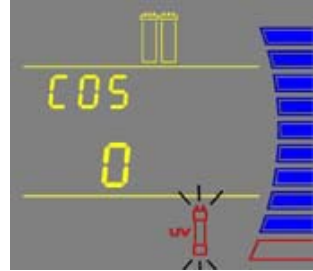

3



Press the "+" and "-" Buttons together. This will reset the UV Timer to 500 (days). The Display will exit the menu.

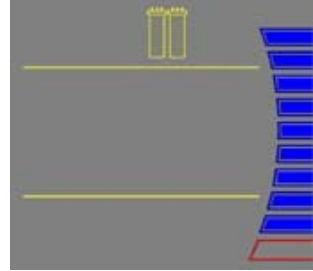



The UV Timer has been reset.

Troubleshooting

Problem	Possible causes	What to do
The Display screen is blank.	<ul style="list-style-type: none"> • The power cord is not plugged in. • No source of electrical power. • Main Power Fuse is blown. 	<ul style="list-style-type: none"> • Check that the power cord is plugged in. • Check the source of electrical power. • Contact your technical support.
In FILLING TANK mode, the Tank Level display is not rising. <i>(The Tank Level display should be rising steadily.)</i>	<ul style="list-style-type: none"> • The Tank Outlet Valve is open. The water in the tank is diverted into the drain. No water is kept in the tank. • The tank level is not calibrated properly. • The RO membrane is dirty or clogged. 	<ul style="list-style-type: none"> • Close the Tank Outlet Valve. • Check the Feedwater source. • See <i>Section How to Calibrate the Tank Level (C04)</i>. • Replace the SmartPak cartridge.
Low water flow or no water flow when the Dispensing Button is pressed.	<ul style="list-style-type: none"> • The water level is less than 10%. No dispensing is allowed. • The Tank Outlet Valve is open. The tank is not filling up with water. • Millipak Filter is air locked. • Final Filter is clogged. 	<ul style="list-style-type: none"> • Allow the system to go into FILLING TANK mode until there is enough water available in the tank, viewed by the Tank Level display. • Close the Tank Outlet Valve. • Vent all air from the Millipak Filter. • Replace the Final Filter, see <i>Section How to Replace the Final Filter</i>.
DISPENSING mode continuously runs even when the Tank Level display is below 10%.	<ul style="list-style-type: none"> • The water level is not calibrated. The system does not detect the minimum level to disable DISPENSING mode. 	<ul style="list-style-type: none"> • Calibrate the tank level. See <i>Section How to Calibrate the Tank Level (C04)</i>.
AUTO-DISPENSING mode is not accurate.	<ul style="list-style-type: none"> • The Product Water flowrate is not calibrated. • The Final Filter is clogged or airlocked. 	<ul style="list-style-type: none"> • Calibrate the Product Water flowrate. See <i>Section How to Calibrate the Flowrate from the Direct-Q System (F02)</i>. • Replace the Final Filter.
The last RO Permeate conductivity value is not displayed when you press the "+" button.	<ul style="list-style-type: none"> • The measurement was not made while dispensing water during FILLING TANK mode. • The value is out of measurement range. 	<ul style="list-style-type: none"> • Dispense water during FILLING TANK mode to start a RO Permeate conductivity reading again.

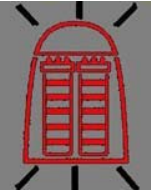
Troubleshooting

Problem	Possible causes	What to do
<p>The last Product resistivity value is not displayed when you press the “-” button in FILLING TANK mode or in PRE OPERATE mode.</p>	<ul style="list-style-type: none"> • A measurement was not made during DISPENSING mode or during recirculation. • The value is out of measurement range. 	<ul style="list-style-type: none"> • Dispense or recirculate water manually to start a Product resistivity reading again.
	<ul style="list-style-type: none"> • The Tank Outlet Valve is not open. The system detects that there is water in the tank. The system will not resume FLUSH mode until the tank is emptied of water. 	<ul style="list-style-type: none"> • Open the Tank Outlet Valve to drain the water from the tank. • Check that the Tank Outlet Valve and Tubing are directed downwards into the drain.
	<ul style="list-style-type: none"> • The SmartPak cartridge lifetime is exhausted. • The Product resistivity is less than the Resistivity Setpoint set in menu option C02. 	<ul style="list-style-type: none"> • Replace the SmartPak cartridge. See <i>Section How to Replace the SmartPak Cartridge</i>.
	<ul style="list-style-type: none"> • The SmartPak cartridge is not installed correctly or not installed at all. 	<ul style="list-style-type: none"> • Reinstall the SmartPak cartridge. • If the red Pack Alarm is still displayed, then contact your technical support.
	<ul style="list-style-type: none"> • The system may have been in STANDBY mode for a while. • The Product resistivity is below the Resistivity Setpoint set in menu option C02. 	<ul style="list-style-type: none"> • Recirculate the water in the system. See <i>Section How to recirculate water manually before dispensing</i>. • Replace the SmartPak cartridge. See <i>Section How to Replace the SmartPak Cartridge</i>.

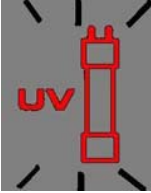
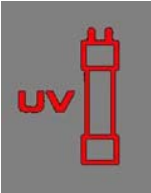
Problem	Possible causes	What to do
 <p>UV System only</p>	<ul style="list-style-type: none"> The UV Timer is exhausted. 	<ul style="list-style-type: none"> Replace the UV Lamp. See <i>Section How to Replace the UV Lamp (UV System only)</i>. After a new UV Lamp has been installed, reset the UV Timer. See <i>Section How to View or Reset the UV Lamp Timer (C05)</i>.
 <p>UV System only</p>	<ul style="list-style-type: none"> The UV Lamp is not installed correctly or not installed at all. 	<ul style="list-style-type: none"> Power OFF the system and reinstall the UV Lamp. If the red UV Lamp Alarm is still displayed, then contact your technical support.

Catalogue Numbers for Direct-Q Systems

For 230 VAC, 120 VAC, 100 VAC:

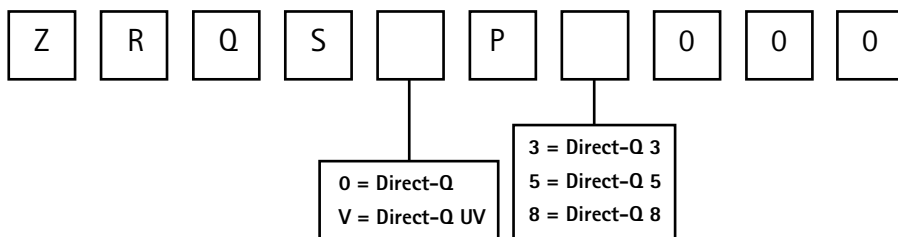

Catalogue Numbers for Consumables

Consumable Item	Catalogue Number
SmartPak DQ3	SPR00SIA1
SmartPak DQ3 LT	SPR0LSIA1
SmartPak DQ8	SPR08SIA1
Millipak Express 20 (Non-Sterile) - 1/box	MPGP02001
BioPak® Ultrafiltration Cartridge	CDUFBI001
EDS-Pak® Final Filter	EDSPAK001
VOC-Pak™ Final Filter	VOCPAK001
EDS-Pak Installation Kit - ordered 1 time only for multiple EDS-Pak uses.	EDSKIT001
Millipak Express 40 Final Filter	MPGP04001
Millex® Vent Filter (1µm), 2/box	TANKMPK03
UV Lamp 185 nm	SYN185UV1
Sanitization Kit	SANIKIT01
Pre-treatment Pack	PROG0000S1

Catalogue Numbers for Accessories

Accessory Item	Catalogue Number
Wall Mounting Bracket	WMBSMT001
Tank Connector Kit	TANKPECKT
30 Litre PE Reservoir	TANKPE030
60 Litre PE Reservoir	TANKPE060
Wall Mounting Bracket for pre-treatment Pack	ZFPACKSPO

Quick access to most common procedures

Checking water quality	38
Contacting Millipore SAS	2
Delivering a fixed ultrapure water volume.....	31
Delivering ultrapure water.....	33
Improving ultrapure water quality by recirculation before sourcing water	37
Replacing the Millipak end filter.....	48
Replacing the SmartPak DQ.....	43
Replacing the tank vent filter	46
Replacing the UV lamp.....	63
Review on-line e-learning on how to use & maintain the system.....	2
Sourcing pure water from the tank.....	33



FTPF09550



V5.0