

BRUNTON®



PRECISION TRANSITS

This manual contains important information about the use and maintenance of this transit. Store it in a safe place for future reference and be sure to read it completely before use.

Owner's Purchase Record

Model _____

Date of Purchase _____

Dealer Purchased From: _____

Serial #:

BRUNTON®

POCKET TRANSIT INSTRUCTION MANUAL

1 – IMPORTANT INFORMATION	Page(s): 1
2 – ORIENTATION	2
3 – MAGNETIC DECLINATION	4
4 – AZIMUTH MEASUREMENT	6
5 – VERTICAL & PERCENT GRADE MEASUREMENT	9
6 – COMPASS USE WITH A TOPOGRAPHIC MAP	12
7 – ADDITIONAL MEASUREMENT	13
8 – REFERENCE MATERIAL	20
9 – SPECIFICATIONS	21
10 – SERVICE	22

Copyright BRUNTON OUTDOOR, INC, 2017
Rev. Version January 2020

1 -- Important Information

Congratulations on your purchase of the finest pocket transit instrument in the world. The Brunton Pocket Transit is not just a compass. It combines a surveyor's compass, inclinometer, prismatic compass and hand level into a single instrument. Use the Brunton Pocket Transit to measure azimuth (compass bearing), vertical angles, inclination of objects, percent grade, slopes, height of objects, and for leveling.

Even though all Brunton Pocket Transits are made to be rugged, durable and withstand the rigor associated with outdoor use, care must be taken to assure long life of your instrument. Avoid impacts, dropping, and extreme temperatures. Store it in its case, and the Brunton transit will perform well for many years.

1.1 Opening The Pocket Transit

Rotate the pocket transit until the flat cover faces up, and the small window is positioned away from you. Unlatch the cover from the base. (Fig 1)



Figure 1

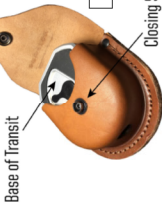

Figure 2

1.2 Protecting The Mirror

While in storage, Brunton recommends placing the pocket transit in the case, with the base against the closing snap. (Fig 2)

1.3 Direct Reading

Why are EAST & WEST switched?

Because the pocket transit is a **direct reading** compass. Read azimuth **directly** where the needle points on the graduated circle.

With the **large sight** toward the object, read azimuth directly where the **north** end of the needle

1

points (white tip - 2001, 2061, 5005LM and 5006LM models, or "N" tip - 5007, 5008 Compro models and 5020 and 5021 Standard Transit models). (Fig 3)

Figure 3



With the **small sight** toward the object, read azimuth directly where the south end of the needle points (**black** tip - 2001, 2061, 5005LM and 5006LM, or "S" tip - 5007, 5008 Compro models and 5020 and 5021 Standard Transit models). (Fig 4)

Figure 4



Detailed explanation of sighting an azimuth is in section 4.

2 -- Orientation

Orientation provides a description of important pocket transit parts. A detailed description of its operation is provided throughout the manual.

2.1 Needle (Fig 5)

The needle is induction damped, which allows the needle to seek magnetic north and come to a complete rest in a minimum amount of time, without accuracy degradation.

2

1 -- Important Information

Congratulations on your purchase of the finest pocket transit instrument in the world. The Brunton Pocket Transit is not just a compass. It combines a surveyor's compass, inclinometer, prismatic compass and hand level into a single instrument. Use the Brunton Pocket Transit to measure azimuth (compass bearing), vertical angles, inclination of objects, percent grade, slopes, height of objects, and for leveling.

Even though all Brunton Pocket Transits are made to be rugged, durable and withstand the rigor associated with outdoor use, care must be taken to assure long life of your instrument. Avoid impacts, dropping, and extreme temperatures. Store it in its case, and the Brunton transit will perform well for many years.

1.1 Opening The Pocket Transit

Rotate the pocket transit until the flat cover faces up, and the small window is positioned away from you. Unlatch the cover from the base. (Fig 1)

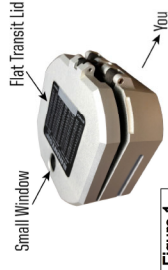

Figure 1

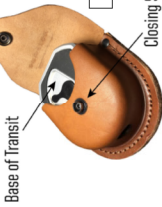

Figure 2

1.2 Protecting The Mirror

While in storage, Brunton recommends placing the pocket transit in the case, with the base against the closing snap. (Fig 2)

1.3 Direct Reading

Why are EAST & WEST switched?

Because the pocket transit is a **direct reading** compass. Read azimuth **directly** where the needle points on the graduated circle.

With the **large sight** toward the object, read azimuth directly where the **north** end of the needle

1

points (white tip - 2001, 2061, 5005LM and 5006LM models, or "N" tip - 5007, 5008 Compro models and 5020 and 5021 Standard Transit models). (Fig 3)

Figure 3



With the **small sight** toward the object, read azimuth directly where the south end of the needle points (**black** tip - 2001, 2061, 5005LM and 5006LM, or "S" tip - 5007, 5008 Compro models and 5020 and 5021 Standard Transit models). (Fig 4)

Figure 4



Detailed explanation of sighting an azimuth is in section 4.

2 -- Orientation

Orientation provides a description of important pocket transit parts. A detailed description of its operation is provided throughout the manual.

2.1 Needle (Fig 5)

The needle is induction damped, which allows the needle to seek magnetic north and come to a complete rest in a minimum amount of time, without accuracy degradation.

2

Figure 5

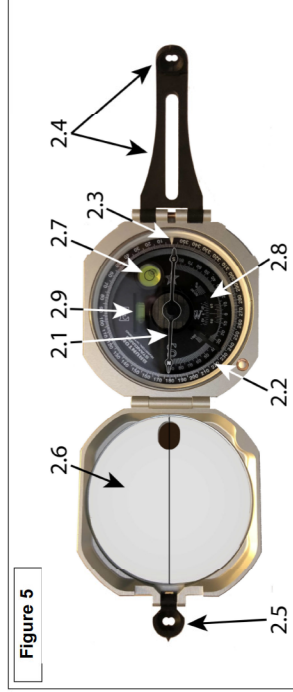

2.2 Graduated Azimuth Ring (Fig 5)

In combination with the needle, the 1° graduated ring allows accurate 1/2° azimuth readings on both the Degree (0° through 360°) and Quadrant (0° through 90°) graduated circles.

2.3 Zero Pin (Fig 5)

The zero pin is the pointer used for magnetic declination adjustment. If no adjustment is necessary, the pin should point at 0°.

2.4 Large Sight w/ Peep Sight (Fig 5)

The large sight and the attached peep sight are used for precise azimuth measurement.

2.5 Small Sight (Fig 5)

Attached to the cover, the small sight is used for precise bearing and inclination sighting.

2.6 Mirror (Fig 5)

Located on the inside of the cover, the mirror and mirror center line are used for accurate azimuth measurements, when using the transit as a prismatic compass.

2.7 Round Level (Fig 5)

Use the round level to level the pocket transit for azimuth measurement.

3

2.8 Vernier (Fig 5)

The adjustable vernier is used in inclination measurements.

2.9 Long Level (Fig 5)

The long level for inclination measurement. Adjust the long level using the vernier adjustment - 2.11.

2.10 Az. Ring Adjusting Screw (Fig 6)

With a screw driver, rotate the graduated circle by turning the circle adjusting screw.

Figure 6

MODEL SHOWN: STANDARD TRANSIT

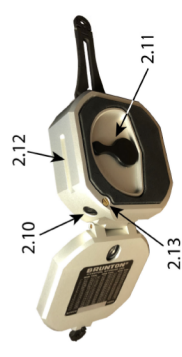

2.11 Vernier Adjustment (Fig 6)

Use the vernier adjustment to adjust the vernier and long level for inclination measurements.

2.12 Ball & Socket Tripod Mount (Fig 6)

The slots on both sides of the body are for mounting to an optional Brunton tripod.

2.13 Azimuth Adjust Look Screw (Fig 6)

This screw holds the azimuth ring adjustment screw (2.10) in place. Give it a half turn out to adjust the azimuth adjustment screw (for declination) and then tighten it back in place.

3 -- Magnetic Declination

The Earth is completely surrounded by a magnetic field, and an unobstructed magnetized object will orient itself with the earth's magnetic north and south poles. Magnetic declination (variation) is the difference between true geographic north (north pole) and magnetic north (in northern Canada), with respect to your position. It is important to note magnetic declination at your position, because magnetic declination varies and fluctuates slowly at different rates around the world. (Fig 7, p.5)

4

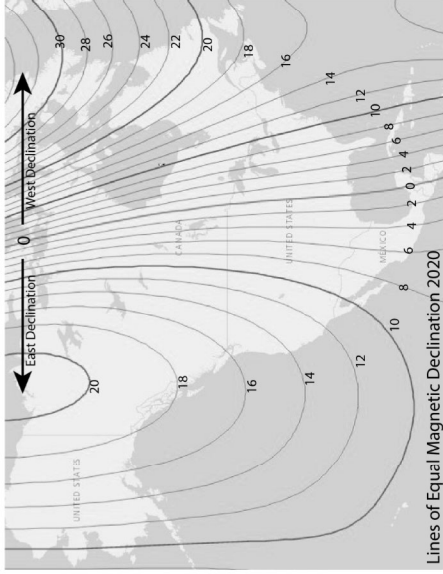

Figure 7

The isogonic chart shows North America, only. Use an isogonic chart, or current United States Geological Survey (USGS), Bureau of Land Management (BLM), or another map to determine magnetic declination at your position.

Declination can be east, west or even 0°, from your current position. At 0° declination, true north and magnetic north are aligned.

Example: If magnetic declination at your position is 15° east, then magnetic north is 15° east of true geographic north. Figure 8 displays true geographic north and magnetic north, as indicated in the legends of USGS and BLM maps.

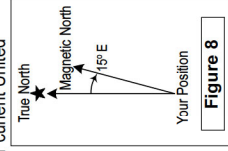

Figure 8

5

tripod using Brunton's Ball and Socket head. See section 11 for ordering information.

1. Adjust pocket transit for magnetic declination.
 - See section 4, **Magnetic Declination**, for help.
2. Mount transit to the ball and socket head.
3. Open both the cover and large sight, until they extend parallel to the body. (Fig 10)
4. Flip small sight and peep sight up. (Fig 10)
5. Rotate transit until large sight points at object
6. Level the transit by centering bubble in round level.
7. Sight azimuth by aligning peep sights with object. (Fig 11)



Figure 11

4.2 Azimuth Measurement Waist-Level

This method is often used when object is above or below the observer.

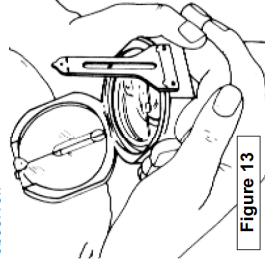

Figure 13

4.2.a Using "N" End of Needle
This method is often used when the object lies as much as 45° above, or 15° below the observer:

1. Hold transit waist high and in your left hand.
2. Open cover toward your body to approximately 45°.
3. Open large sight, until perpendicular to the body. (Fig 13)

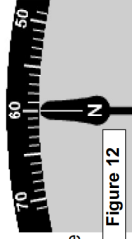

Figure 12

8. Read azimuth where the "N" end of the needle points at graduated circle – 60°. (Fig 12)



Figure 10

Most maps use true north as a reference. When adjustment for magnetic declination is complete, azimuth readings will be with respect to true north, same as the map.

To adjust for magnetic declination, rotate the graduated circle by turning the circle adjusting screw. Begin with the zero pin at 0°. For **East** declination, rotate graduated circle **clockwise** from the zero pin. (Fig 9A) For **West** declination, rotate graduated circle **counterclockwise**. (Fig 9B) If magnetic declination is 0°, no adjustment is necessary. (Fig 9C)

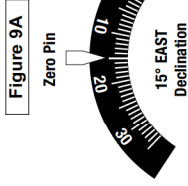

Figure 9A

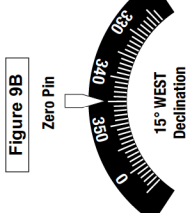

Figure 9B

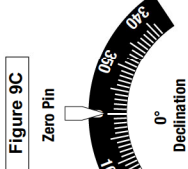

Figure 9C

4 -- Azimuth Measurement

Azimuth is a term used for direction. Azimuth is normally measured clockwise, in degrees with true north being 0°. Bearing is a term often used when measuring with a quadrant type instrument. From this point forward, description of pocket transit use will involve the 0° through 360° graduated ring, and assume the pocket transit is adjusted for magnetic declination. Example of azimuth: If a mountain is directly east of your position, the azimuth from your position to the mountain is 90°. If the mountain is directly south of your position, it would be at 180°.

Caution: The magnetic needle is highly sensitive. When sighting an azimuth, keep the pocket transit away from magnetic materials, such as watches, belt buckles, rings, knives, cigarette lighters, ... etc.

4.1 Azimuth Using a Tripod or Unipod

When the greatest accuracy is required, mount the pocket transit on a Brunton non-magnetic

6

4. Press left forearm against your waist and steady with right hand.
5. Level compass using round bubble level.
6. Look into the mirror, and bisect the large sight and the object with mirror center line. (Fig 14)

• Check that bubble is centered in round bubble level.

7. Read azimuth where the "N" end of needle points at the graduated circle.

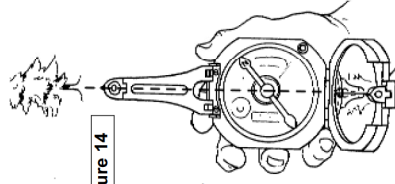

Figure 14

If object is more than 45° above you, open mirror further toward your body, and adjust large sight so that it leans over the bottom case. Then repeat the procedures described in 4.2.a.

4.2.b Using "S" End of Needle

Use this method when object is more than 15° below the observer.

1. Hold transit waist high and in your left hand.
2. Open cover away from your body to approximately 45° from level. (Fig 15)
3. Open large sight, until it leans over the body at approximately 45°. (Fig 15)
4. Press left forearm against your waist and steady with right hand.
5. Level compass using round bubble level.
6. Look just over the large sight, and at the object through window opening on mirror. (Fig 15)

• Adjust mirror and large sight so the image of the large peep sight are bisected by the mirror center line.

- Check that bubble is centered in round bubble level.
7. Read azimuth where the "S" end of needle points at the graduated circle. (Fig 16)

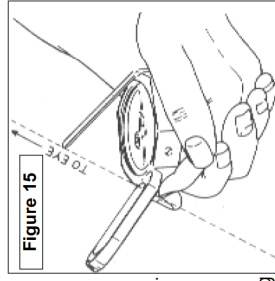

Figure 15

4.3 Using as a Prismatic Compass

Occasionally, objects may interfere with sighting using

7

methods previously mentioned, or user may encounter circumstances which require the transit be held at eye-level to sight an object. If this is the case, follow the procedures below.

1. Open cover away from your body to approximately 45°, and open small sight. (Fig 17)
2. Lift large sight until perpendicular to the body, or leans slightly away from the base. (Fig 17)
3. Hold instrument at eye-level, with large sight toward you.
4. Align large sight and small sight on top of the cover with object.
 - OR - Sight object through the lower portion of large sight and the window in the mirror.
5. Level round bubble level in the reflection of the mirror.
6. Read azimuth in the reflection of the mirror, where the "S" end of needle points at the graduated circle.

5 -- Vertical & Percent Grade Measurement

The Brunton Pocket Transit is capable of measuring vertical angles with accuracy better than 1°, with readings to 10 minutes. It can also display percent grade, without any calculation.

The bottom scale is incremented from 0° to 90° and is used for vertical inclination. The scale on the vernier is also used for vertical (inclination) measurement, but it is incremented from 0 to 60 minutes. (Fig 18). Closer to the center, the second scale increments from 0% to 100%. This scale is the percent grade scale.

5.1 Inclination and Percent Grade Using Tripod

9

Example: $\tan(26.5^\circ) = .499 = 49.9\% \text{ Grade}$

5.2 Inclination Using Prismatic Compass

The pocket transit can also measure angles of inclination without a tripod.

1. Open small sight and large sight as far as possible.
2. Flip peep sight up on large sight.
3. Position Cover to approximately 45°.
4. With large sight pointing toward you, position transit at eye-level with cover open to the left. (Fig 21)
5. Sight object behind transit, aligning small sight, window and peep sight with object.
6. In mirror, adjust vernier until bubble in long level is centered.
5. Read inclination or percent grade at vernier's center line.

5.2.a Height Measurement Using Vertical Angles

1. Sight inclination, as described in section 5.2.
2. Apply height calculation as shown in Figure 22A or 22B.

Note: Do not calculate tangent of an angle by adding tangents of two smaller angles.

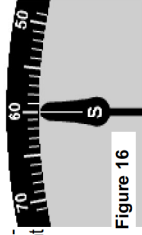
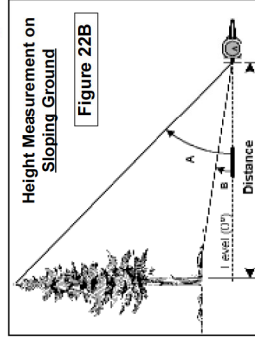
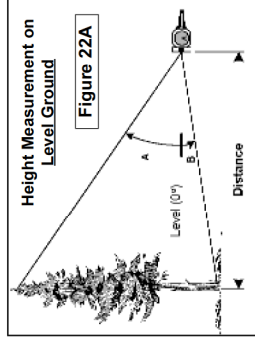

Figure 16

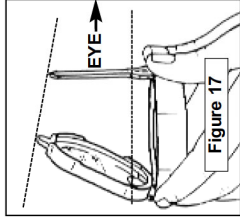

Figure 17

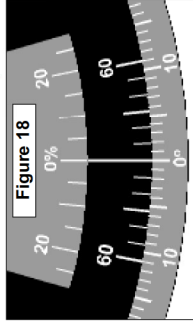

Figure 18

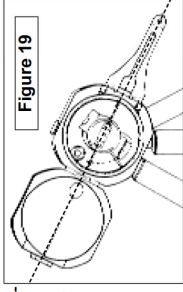

Figure 19

Use a tripod, or unipod for greatest inclination accuracy possible.

1. With pocket transit attached to the tripod using the ball and socket mount, tilt the head 90°. (Fig 19).
- Transit should be on its side.
2. Lock into position using the clamp screw.
3. Align sights with object behind transit. (Fig 19)
4. Adjust vernier until bubble is centered in long level.
5. Read inclination at vernier's center line from the degree scale -- 26°. (Fig 20)

5.1.a -- Inclination to the nearest 30 minutes

When 30 minute readable accuracy is required, use the vernier scale (0-60 min. with 10 min. increments).

1. Read inclination at vernier's center line -- 26° + ??.
2. Find minutes by determining whether the 30 or 60 min. line is closest to a degree marking.
 - A Loupe or magnifier may be required.

Since the 30 minute line is closest, the total angle is 26° + 30' (26° 30' or 26.50°)

5.1.b -- Percent grade

When percent grade is required use the percent scale directly above the vernier.

1. Read nearest percent grade at the vernier's center line -- 50%. (Fig 20)

For greater accuracy, calculate the percent grade using the following equation.

$$\text{Percent Grade} = [\tan(\theta) \times 100]$$

Measure the angle of inclination, $\theta = 26.5^\circ$. Then calculate the tangent of 26.5° using a calculator. Finally, move the decimal two places to the right (multiply by 100).

10

Level Ground

$$\text{Height} = (\tan A + \tan B) \times \text{Distance}$$

Example: A = 36°, B = 10° & Distance = 50 ft.

$$\text{Height} = (\tan(36^\circ) + \tan(10^\circ)) \times 50'$$

$$\text{Height} = (.727 + .176) \times 50$$

$$\text{Height} = (.903) \times 50$$

$$\text{Height} = 45.15 \text{ ft.} = 45'$$

Example: $\tan(60^\circ) \neq \tan(30^\circ) + \tan(30^\circ)$ Find $\tan(60^\circ)$ from a table, use a calculator, or step back until angle of inclination is less than 45°.

Sloping Ground

$$\text{Height} = (\tan A - \tan B) \times \text{Distance}$$

Example: A = 38°, B = 10° & Distance = 75 ft.

$$\text{Height} = (\tan(38^\circ) - \tan(10^\circ)) \times 75'$$

$$\text{Height} = (.781 - .176) \times 75$$

$$\text{Height} = (.605) \times 75$$

$$\text{Height} = 45.38 \text{ ft.} = 45'$$

5.2.b Height Measurements Using % Grade

Level Ground

$$\text{Height} = (A + B) \times \text{Distance}$$

Example: A = 72.7%, B = 17.6% & Distance = 50 ft.

$$\text{Height} = (.727 + .176\%) \times 50'$$

$$\text{Height} = (.903) \times 50'$$

$$\text{Height} = 45.15 \text{ ft.} = 45'$$

Sloping Ground

$$\text{Height} = (A - B) \times \text{Distance}$$

Example: A = 78.1%, B = 17.6% & Distance = 75 ft.

$$\text{Height} = (.781\% - .176\%) \times 75'$$

$$\text{Height} = (.605) \times 75'$$

$$\text{Height} = 45.38 \text{ ft.} = 45'$$

Figure 23A

Figure 23B

6 -- Compass Use with a Topographic Map

1. Sight % Grade using level or sloping ground, same as in Figures 22A & B, p. 11.
 2. Apply height calculation, as shown in figures 23A & 24B.
- A United States Geological Survey (USGS) topographic map is a 2-dimensional drawing of a 3-dimensional terrain. Hills, valleys, ridges, cliffs and other terrain are represented through a series of contour lines. Each line represents constant elevation in feet or meters above sea level. Find the contour interval in the legend of the topo-map. With practice, you'll begin to recognize contours, labeling and identify passable routes.

6.1 Map Azimuth

1. On the topo-map, place a "point" at a starting position and an "X" at a destination.

11

12

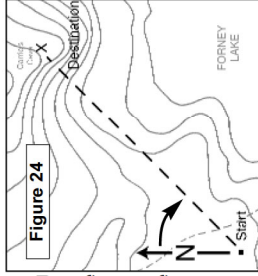

2. Draw a line connecting both marks.
3. At the starting position, draw a true north line. (Fig 24, p. 13)

- Use true north indicator in the legend, or the edge of printed topo-map for reference.
4. Using the Alidade (Com-Pro models only), or a protractor, find the angle from the starting position to the destination, "X".

Remember, the true north line is 0°.

From the start position in the field, sight azimuth determined from the map, and you will be facing the destination. See section, 4 - Azimuth Measurement, for help.

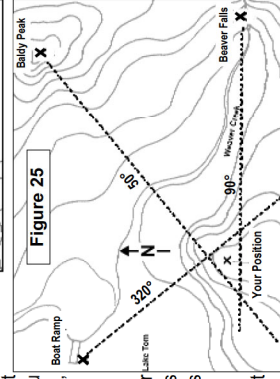

6.2 Triangulation

Triangulation is a method used to find your approximate position, using a compass and a map. Make sure the pocket transit is adjusted for magnetic declination.

1. Identify three landmarks in the field, that you can identify on a topo-map.
2. Sight an azimuth to each land mark and document.
3. Draw an azimuth line on the map for each azimuth.

7 -- Additional Measurement

4. Your position is within the small triangle, or position formed by the intersection of the three lines. (Fig 25)

7.1 Level

13

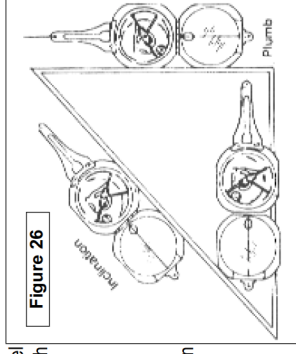

The transit can be used as a level, to run level lines, or to determine points of elevation which is the same as the users eyes.

1. Adjust Vernier to 0° inclination, using the lever on the back of the body.
2. Place transit on its side, on an object, or use the tripod. (Fig 26)
3. Tilt instrument until the bubble is centered in the long level.

7.2 Plumb Bob

1. Suspend the transit in an open position from the large peep sight. (Fig 26)
2. Use the small sight as the pointer.

7.3 Inclination

8 -- Reference Material

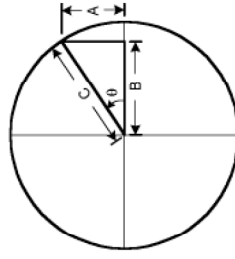

$$\begin{aligned} \text{SIN}(\theta) &= A/C \\ \text{COS}(\theta) &= B/C \\ \text{TAN}(\theta) &= A/B \\ \text{CSC}(\theta) &= C/A \\ \text{SEC}(\theta) &= C/B \\ \text{COT}(\theta) &= B/A \end{aligned}$$

A = side opposite angle θ
B = side adjacent to angle θ
C is the hypotenuse

$$C^2 = A^2 + B^2$$

14

Inches	Feet	mm	cm	Conversions	Conversions
1/8	0.0104	3.1750	.31750	1 inch = 2.54 centimeters	1 centimeter = 10 millimeters
1/4	0.0208	6.3500	.63500	1 foot = 12 inches	1 centimeter = 0.01 meters
3/8	0.0313	9.5250	.95250	1 foot = 0.305 meters	1 centimeter = 0.394 inches
1/2	0.0417	12.700	1.2700	1 yard = 3 feet	1 meter = 100 centimeters
5/8	0.0521	15.875	1.5875	1 yard = 0.914 meters	1 meter = 3.281 feet
3/4	0.0625	19.050	1.9050	1 chain = 66 feet	1 meter = 1.094 yards
7/8	0.0729	22.225	2.2225	1 mile = 5,280 feet	1 kilometer = 1,000 meters
1	0.0833	25.400	2.5400	1 mile = 80 chains	1 kilometer = 0.6214 miles
2	0.1667	50.800	5.0800	1 mile = 1.609 kilometers	1 hectare = 10,000 meters ²
3	0.2500	76.200	7.6200	1 acre = 43,500 feet ²	1 hectare = 2.471 acres
4	0.3333	101.60	10.160		
5	0.4167	127.00	12.700		
6	0.5000	152.40	15.240		
12	1.0000	304.80	30.480		

9 -- Specifications

Magnetism:

Models - 2001 & 2061 (Alnico II Bar Magnet)
Models - 5005LM & 5006LM (Alnico V Bar Magnet)
Models - 5007, 5008, 5020, 5021 (NiFeB Magnet)

Accuracy:

Bearing -- +/- 1/2° accurate
Inclination -- +/- 1° accurate (30 minute readable)

Size (Closed):

Width -- [2001, 2061, 5005LM & 5006LM models] - 2.79 in. (7.09 cm)
Width -- [5007, 5008, 5020, 5021 models] - 2.76 in. (7.01 cm)

Length -- [2001, 2061, 5005LM & 5006LM models] - 3.09 in. (7.84 cm)
Length -- [5007, 5008, 5020, 5021 models] - 3.14 in. (7.97 cm)

Height -- [2001, 2061, 5005LM & 5006LM models] - 1.31 in. (3.34 cm)
Height -- [5007, 5008, 5020, 5021 models] - 1.33 in. (3.38 cm)

Weight -- [2001, 2061 models] - 6.8 oz (193 g)
Weight -- [5005LM & 5006LM models] - 7.1 oz (201 g)
Weight -- [5007, 5008 models] - 5.7 oz (162 g)
Weight -- [5020, 5021 models] - 7.0 oz (198 g)

10 -- Service

Repair / Service - Brunton™'s repair department is capable of handling repairs, or conversions of any genuine Brunton Pocket Transit. Periodic maintenance and calibration is highly recommended and will prolong the life of your pocket transit. Requests for warranty may be made by contacting Warranty Services at 1-800-443-4871 or info@bruntongroup.com.

15

16

Accessories



305 Jacob Staff Thimble
Attaches transit to steel tipped wooden rod or Jacob's staff. Ball and socket head is also required.

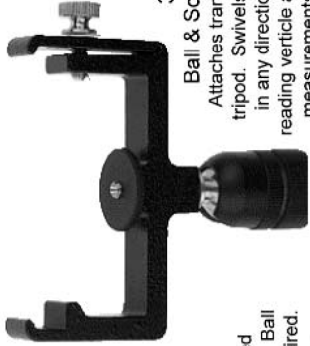

3040 Ball & Socket
Attaches transit to tripod. Swivels 90° in any direction for reading vertical angle measurements and rotates 360° for horizontal measurements.



3051 Non Magnetic Tripod
(shown with transit attached)
Provides maximum accuracy for transit readings. Sturdy extruded aluminum legs, cast aluminum top and heavy duty joints. 48" extended, 19 1/2" closed.

17

Brunton Limited Warranty:

Brunton warrants your manufactured product to remain free of defects during the warranty period. Brunton's products are intended to be used in harsh outdoor environments. As such, the Brunton Limited Warranty does not cover normal wear and tear, damage due to misuse or rough handling or chemical exposure, and alteration. Product not registered will not be covered under the Brunton Limited Warranty.

Warranty Period:

The Brunton Limited Warranty is valid for one year from the date of purchase. Products seeking warranty must be accompanied by proof of original purchase and completion of Product Registration on Brunton.com.

Obtaining access to Brunton Limited Warranty:

Requests for warranty may be made by contacting Warranty Services at

1-800-443-4871 or info@bruntongroup.com

Should a defect occur in your Brunton branded product which is not due to negligence or by fault or accident, and if the product qualifies for the Brunton Limited Warranty, we shall, at our option, either repair or replace it without charge, and will pay the cost of return shipment to you (you must pay for cost of shipment to Brunton).

Refunds are only available for those items purchased directly from Brunton.com within 30 days of purchase.

Limitation of Liability:

BRUNTON SHALL NOT BE LIABLE FOR INCIDENTAL OR CONSEQUENTIAL DAMAGES. THERE ARE NO OTHER EXPRESS WARRANTIES BEYOND THE BRUNTON LIMITED WARRANTY UNLESS MANDATORY LAW PROVIDES OTHERWISE. THESE WARRANTY TERMS ARE SUBJECT TO CHANGE WITHOUT NOTICE.

18

Precision Instruments Handmade in Riverton, WY Since 1894
BRUNTON®

2255 Brunton Court

Riverton, WY 82501

Phone: 1.800.443.4871

Fax: 303.996.3758

www.brunton.com